

# THE SOLUTION BOOK

TO LEAD AN EASY LIFE



Makes life easy





Makes life easy

# ABOUT POLAR

---

Every lifestyle is unique and every home tells a different story. In today's fast-paced world, it has become increasingly difficult to keep up with the plethora of tasks for everyday living. This is where Polar has made a difference and continues to do so, with its ingenious range of home appliances and heaters. A company with national repute, Polar has maintained its leading position over the decades, with efficient technological solutions for Indian households. Polar is committed to simplifying daily chores with its extensive range of home appliances and heaters. Its vast range of products, including water heaters, room heaters, immersion rods, irons, mixer grinders and kitchen appliances, have been designed to cater to the ever-evolving needs of a modern family.

MAKE EVERY DAY  
EFFORTLESS

A COSY  
BATHING  
EXPERIENCE

---



POLAR

Marbella

POLAR

Lava+

WATER  
HEATER

---



# MARBELLA | Storage Water Heater

(Available in 10, 15 & 25 litres)



Glass Lined Metal Tank



8 Bar Pressure



Pentashield Safety



High-density PUF Insulation



Temperature Control Knob



Whirlflow Technology

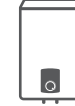

Long-lasting Metal Body



Anti-corrosion Magnesium Rod



Rated Power 2000 W



ISI Approved

- Titanium enamel & blue sapphire coated Glass Lined Metal Tank for corrosion-free, long-lasting performance
- Designed for 8 bar pressure – suitable for high-rise buildings
- Magnesium anode rod with O-PRO technology enhances the life of the tank & heating element
- High-density PUF insulation keeps the water hot for a long time
- Whirlflow technology heats water quickly
- Pentashield safety (Capillary Thermal Cut-out/Multi-function Valve/Capillary Thermostat/Dry Heat Protection/Magnesium Anode Rod)
- High efficiency heating element
- \*\*7 years warranty on the inner tank & 2 years warranty on the product

## 7 YEARS\*\* WARRANTY





# HOTWAVE

Storage Water Heater  
(Available in 10, 15 & 25 litres)



Nano Polybond-coated  
Robust Steel Tank



8 Bar  
Pressure



Nickle-coated  
Heating Element



Anti-corrosion  
Magnesium Rod



Whirlflow  
Technology



Shock & Corrosion  
Proof ABS Body



Temperature  
Control Knob



Rated Power  
2000 W



Smart LED  
Indicator



ISI  
Approved

- Nano polybond-coated robust steel tank ensures corrosion resistance in high temperature & pressure
- Designed for 8 bar pressure – suitable for high-rise buildings
- Nickel-coated high-efficiency heating element
- Anti-corrosion magnesium anode rod with O-PRO technology enhances the life of the tank & heating element
- Whirlflow technology heats water quickly
- High-density PUF insulation keeps the water hot for a long time
- Pentashield safety (Capillary Thermal Cut-out/Multi-function Valve/ Capillary Thermostat/Dry Heat Protection/Magnesium Anode Rod)
- \*\*5 years warranty on the inner tank and 2 years on the product

**5 YEARS\*\***  
WARRANTY







## GUSH | Storage Water Heater (Available in 6, 10, 15 & 25 litres)



- Titanium enamel & blue sapphire coated Glass Lined Metal Tank for corrosion-free, long-lasting performance
- Designed for 8 bar pressure – suitable for high-rise buildings
- Magnesium anode rod with O-PRO technology enhances the life of the tank & heating element
- Whirlflow technology heats water quickly
- High-density PUF insulation keeps the water hot for a long time
- Pentashield safety (Capillary Thermal Cut-out/Multi-function Valve/Capillary Thermostat/Dry Heat Protection/Magnesium Anode Rod)
- High efficiency heating element
- \*\*7 years warranty on the inner tank & 2 years warranty on the product



**7 YEARS\*\*  
WARRANTY**





## LAVA+ | Storage Water Heater (Available in 10, 15 & 25 litres)



Long-lasting  
Metal Body



8 Bar  
Pressure



Pentashield  
Safety



High-density  
PUF Insulation



Temperature  
Control Knob



Whirlflow  
Technology



Anti-corrosion  
Magnesium  
Rod



Corrosion  
Proof Metal  
Tank



Rated Power  
2000 W



ISI  
Approved

- Designed for 8 bar pressure – suitable for high-rise buildings
- Long-lasting powder coated metal body
- Whirlflow technology heats water quickly
- High-density PUF insulation keeps the water hot for a long time
- Magnesium anode rod with O-PRO technology enhances the life of the tank & heating element
- Pentashield safety (Capillary Thermal Cut-out/Multi-function Valve/Capillary Thermostat/Dry Heat Protection/Magnesium Anode Rod)
- High efficiency heating element
- \*\*5 years warranty on the inner tank & 2 years warranty on the product











# 5 YEARS\*\* WARRANTY



**Freshet**



# FRESHET | Storage Water Heater (Available in 6, 10, 15 & 25 litres)

- |   |   |   |   |  |
|---|---|---|---|--|
| <br>Glass Lined<br>Metal Tank          | <br>8 Bar<br>Pressure                      | <br>Pentashield<br>Safety              | <br>High-density<br>PUF Insulation | <br>Temperature<br>Control Knob |
| <br>Analogue<br>Temperature<br>Display | <br>Shock<br>& Corrosion<br>Proof ABS Body | <br>Anti-corrosion<br>Magnesium<br>Rod | <br>Rated Power<br>2000 W          | <br>ISI<br>Approved             |

- Titanium enamel & blue sapphire coated Glass Lined Metal Tank for corrosion-free, long-lasting performance
- Designed for 8 bar pressure – suitable for high-rise buildings
- Magnesium anode rod with O-PRO technology enhances the life of the tank & heating element
- Whirlflow technology heats water quickly
- High-density PUF insulation keeps the water hot for a long time
- Pentashield safety (Capillary Thermal Cut-out/Multi-function Valve/Capillary Thermostat/Dry Heat Protection/Magnesium Anode Rod)
- High efficiency heating element
- \*\*7 years warranty on the inner tank & 2 years warranty on the product

**7 YEARS\*\*  
WARRANTY**





## LEGACY+ | Storage Water Heater (Available in 6, 10, 15 & 25 litres)



Glass Lined  
Metal Tank



8 Bar  
Pressure



Pentashield  
Safety



High-density  
PUF Insulation



High Efficiency  
Heating Element



Whirlflow  
Technology



Shock &  
Corrosion Proof  
ABS Body



Anti-corrosion  
Magnesium  
Rod



Rated Power  
2000 W



ISI  
Approved

- Titanium enamel & blue sapphire coated Glass Lined Metal Tank for corrosion-free, long-lasting performance
- Designed for 8 bar pressure – suitable for high-rise buildings
- Magnesium anode rod with O-PRO technology enhances the life of the tank & heating element
- Whirlflow technology heats water quickly
- High-density PUF insulation keeps the water hot for a long time
- Pentashield safety (Thermal Cut-out/Multi-function Valve/Thermostat/Dry Heat Protection/Magnesium Anode Rod)
- 15 & 25 litres are available in horizontal and vertical variants
- \*\*7 years warranty on the inner tank & 2 years warranty on the product

## 7 YEARS\*\* WARRANTY





## LAVA | Storage Water Heater (Available in 10, 15 & 25 litres)



Long-lasting  
Powder Coated  
Metal Body



8 Bar  
Pressure



Pentashield  
Safety



High-density  
PUF Insulation



High Efficiency  
Heating Element



Whirlflow  
Technology



Corrosion  
Proof Metal  
Tank



Rated Power  
2000 W



ISI  
Approved

- Designed for 8 bar pressure – suitable for high-rise buildings
- Magnesium anode rod with O-PRO technology enhances the life of the tank & heating element
- High-density PUF insulation keeps the water hot for a long time
- Whirlflow technology heats water quickly
- Pentashield safety (Thermal Cut-out/Multi-function Valve/Thermostat/Dry Heat Protection/Magnesium Anode Rod)
- \*5 years warranty on the inner tank & 2 years warranty on the product

**5** YEARS\*  
WARRANTY





# AQUAHOT | Storage Water Heater (Available in 6, 10, 15, 25, 35 & 50 litres)



Heavy Gauge  
Stainless Steel  
Tank



6 Bar  
Pressure



High-density  
PUF Insulation



Long-lasting  
Metal Body



Magnesium  
Anode Rod



Rated Power  
2000 W



ISI  
Approved

- Heavy gauge stainless steel (SS304L) tank for longer life
- Designed for 6 bar pressure
- High-density insulation keeps the water hot for a long time
- Metal body with corrosion resistant paint
- Unique safety features – pressure release valve and anti-siphon hole
- High efficiency heating element
- 3-star rated as per BEE standards (\*2-star rated for 35 & 50 litres)
- \*\*5 years warranty on the inner tank & 2 years warranty on the product

**5** YEARS\*\*  
WARRANTY







## REFRESHA PRO | Instant Water Heater (Available in 3 & 5 litres)



Ultra Thick  
Stainless Steel  
Tank



Pentashield  
Safety



Neon  
Indicator



Shock-proof  
& Corrosion  
Resistant Body



Pressure  
Release Valve



Rated Power  
3000/4500 W



ISI  
Approved



- Ultra thick superior 304 grade SS tank with 1.0 mm (5 L) thickness for durability
- Pressure release valve & anti-siphon hole
- ISI approved heating element & thermostat
- High efficiency 3000/4500 W heating element
- \*5 years warranty on the inner tank & 2 years warranty on the product

**5** YEARS\*  
WARRANTY



## COZY | Instant Water Heater (Available in 3 & 5 litres)



Ultra Thick  
Stainless Steel  
Tank



Pentashield  
Safety



Neon  
Indicator



Shock-proof  
& Corrosion  
Resistant Body



Pressure  
Release Valve



Rated Power  
3000 W



ISI  
Approved

- Ultra thick superior 304 grade SS tank with 1.0 mm (5 L) thickness for durability
- ISI approved element & thermostat
- Pressure release valve & anti-siphon hole
- High efficiency 3000 W heating element
- \*5 years warranty on the inner tank & 2 years warranty on the product

## 5 YEARS\* WARRANTY





# INSTAHOT — 6L | Gas Water Heater



4X  
Protection



Automatic  
Ignition



20 Minutes  
Inbuilt Timer



Capacity  
up to 6 L



Low Pressure  
Application



ISI  
Approved

- 4x protection (Flame Failure Protection/Dry Burn Protection/Overheat Protection/Dry Heat Protection)
- Low pressure application — 3PSI



**2** YEARS  
WARRANTY



IMMERSION  
WATER HEATER

---

# IMMERSION

## Electric Immersion Water Heater



Heavy-duty  
Copper Tube



Rated Power  
1000/1500 W



Corrosion  
Proof

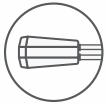

Shock-proof  
Model



3-pin  
Cord



ISI Approved  
3-core Supply  
Cord

- Heavy-duty copper tube filled with magnesium oxide for durability
- ISI approved 3-core supply cord with moulded 3-pin plug

**2** YEARS REPLACEMENT  
WARRANTY



PREPARE  
DELICACIES  
WITH EASE

---



MIXER  
GRINDER





## GALAXY | Mixer Grinder



3-speed  
Control



30 Minutes  
Rating



Food Grade  
Transparent  
& SS Jars



Rated Power  
900 W



Shock-proof  
ABS Body



Auto  
Shut-off



Skid  
Resistant



Powerful  
100% Copper  
Motor



Stainless Steel  
Multi-purpose  
Blades



ISI  
Approved



Powerful  
900 W

- 3-speed control with pulser incher
  - 30 minutes rating (3 minutes ON & 2 minutes OFF)
  - Auto shut-off with overload protector
  - High-grade stainless steel multi-purpose blades
  - Genuine food grade & shock-proof ABS body
  - Transparent polycarbonate blending jars & stainless steel jars\* with dome and cap
  - Skid resistant vacuum legs
  - Speed 19000 RPM
  - \*\*5 years warranty on the motor & 2 years warranty on the product
- \*Liquidising Jar – 1500 ml, Dry Grinding Jar – 1000 ml, Chutney Jar – 400 ml

**5 YEARS\*\***  
WARRANTY



Powerful  
750 W



## MARVEL | Mixer Grinder



3-speed  
Control



30 Minutes  
Rating



Food Grade  
SS Jars



Rated Power  
750 W



Shock-proof  
ABS Body



Auto  
Shut-off



Skid  
Resistant



Powerful  
100% Copper  
Motor



Stainless Steel  
Multi-purpose  
Blades



ISI  
Approved

- 3-speed control with incher
  - 30 minutes rating (3 minutes ON & 2 minutes OFF)
  - Auto shut-off with overload protector
  - Food grade & shock-proof ABS body
  - Stainless steel jars\* and PC dome with buckle clips for secured locks & handsfree operation
  - \*\*5 years warranty on the motor & 2 years warranty on the product
- \*Liquidising Jar – 1500 ml, Dry Grinding Jar – 1000 ml, Chutney Jar – 400 ml

5 YEARS\*\*  
WARRANTY



**Powerful  
750 W**

## MIXO 750 | Mixer Grinder



3-speed  
Control



30 Minutes  
Rating



Food Grade  
SS Jars



Rated Power  
750 W



Shock-proof  
ABS Body



Auto  
Shut-off



Skid  
Resistant



Powerful  
100% Copper  
Motor



Stainless Steel  
Multi-purpose  
Blades



ISI  
Approved

- 3-speed control with incher
  - 30 minutes rating (3 minutes ON & 2 minutes OFF)
  - Auto shut-off with overload protector
  - Food grade & shock-proof ABS body
  - Stainless steel jars\* with transparent PC dome (secure lock for liquid jar)
  - \*\*5 years warranty on the motor & 2 years warranty on the product
- \*Liquidising Jar (secure lock) – 1500 ml, Dry Grinding Jar – 1000 ml, Chutney Jar – 400 ml

**5 YEARS\*\*  
WARRANTY**





## MIXO 500 | Mixer Grinder



3-speed  
Control



30 Minutes  
Rating



Food Grade  
SS Jars



Shock-proof  
ABS Body



Auto  
Shut-off



Skid  
Resistant



Powerful  
100% Copper  
Motor



Stainless Steel  
Multi-purpose  
Blades



ISI  
Approved

- 3-speed control with incher
- Rated power 500 W
- 30 minutes rating (3 minutes ON & 2 minutes OFF)
- Auto shut-off with overload protector
- Food grade & shock-proof ABS body
- Stainless steel jars\* with lid
- \*\*5 years warranty on the motor & 2 years warranty on the product

\*Liquidising Jar – 1250 ml, Dry Grinding Jar – 800 ml, Chutney Jar – 400 ml



**5** YEARS\*\*  
WARRANTY



## ULTRA MIX | Mixer Grinder



3-speed  
Control



30 Minutes  
Rating



Food Grade  
SS Jars



Advance  
Air Ventilation  
System



Shock-proof  
ABS Body



Auto  
Shut-off



Skid  
Resistant



Powerful  
100% Copper  
Motor



Stainless Steel  
Multi-purpose  
Blades



ISI  
Approved

- 3-speed control with incher
- Rated power 500 W
- 30 minutes rating (3 minutes ON & 2 minutes OFF)
- Auto shut-off with overload protector
- Food grade & shock-proof ABS body
- Stainless steel jars\*
- \*\*5 years warranty on the motor & 2 years warranty on the product

\*Liquidising Jar – 1250 ml, Dry Grinding Jar – 800 ml, Chutney Jar – 400 ml

**5** YEARS\*\*  
WARRANTY



# MONARCH 500 | Mixer Grinder



3-speed  
Control



30 Minutes  
Rating



Food Grade  
SS Jars



Shock-proof  
ABS Body



High-speed  
Universal  
Motor



Auto  
Shut-off



Skid  
Resistant



ISI  
Approved



- 3-speed control with incher
- Rated power 500 W
- 30 minutes rating (3 minutes ON & 2 minutes OFF)
- Auto shut-off with overload protector
- Food grade (SS304) stainless steel jars\* with lid
- Anti-skid vacuum feet

\*Liquidising Jar – 1250 ml, Dry Grinding Jar – 800 ml, Chutney Jar – 400 ml

**3** YEARS  
WARRANTY



## SPYDER 500 | Mixer Grinder



3-speed  
Control



30 Minutes  
Rating



Food Grade  
SS Jars



Shock-proof  
ABS Body



Auto  
Shut-off



Skid  
Resistant



Powerful  
Universal  
Motor



Stainless Steel  
Multi-purpose  
Blades



ISI  
Approved

- 3-speed control with incher
- Rated power 500 W
- 30 minutes rating (3 minutes ON & 2 minutes OFF)
- Auto shut-off with overload protector
- Food grade & shock-proof ABS body
- Stainless steel jars\* with lid

\*Liquidising Jar – 1250 ml, Dry Grinding Jar – 800 ml, Chutney Jar – 400 ml

**2** YEARS  
WARRANTY



## WINMIX | Mixer Grinder



3-speed  
Control



30 Minutes  
Rating



Food Grade  
SS Jars



Auto  
Shut-off



Anti-skid  
Vacuum  
Feet



High-speed  
Universal  
Motor



Stainless Steel  
Multi-purpose  
Blades



ISI  
Approved



- 3-speed control with incher
- 19000 RPM & 500 W high-speed universal motor
- 30 minutes rating (3 minutes ON & 2 minutes OFF)
- Auto shut-off with overload protector
- Food grade stainless steel jars\* with lid
- \*\*5 years warranty on the motor & 2 years warranty on the product

\*Liquidising Jar – 1200 ml, Dry Grinding Jar – 750 ml, Chutney Jar – 350 ml

**5** YEARS\*\*  
WARRANTY



JUICER MIXER  
GRINDER







## GALAXY | Juicer Mixer Grinder



30 Minutes  
Rating



Shock-proof  
ABS Body



Auto  
Shut-off



Powerful  
Motor



Anti-skid  
Vacuum  
Feet



Stainless  
Steel Blades  
(SS304)



ISI  
Approved



- 3-speed control with incher
- 30 minutes rating (3 minutes ON & 2 minutes OFF)
- Auto shut-off with overload protector
- Food grade & shock-proof ABS body
- Transparent liquidising jar (1.5 L)
- Stainless steel grinding jar (0.8 L)
- Rated power 500 W

**2** YEARS  
WARRANTY

SATISFY YOUR  
CRAVINGS WITH  
A QUICK BREW

---





ELECTRIC  
KETTLE

---

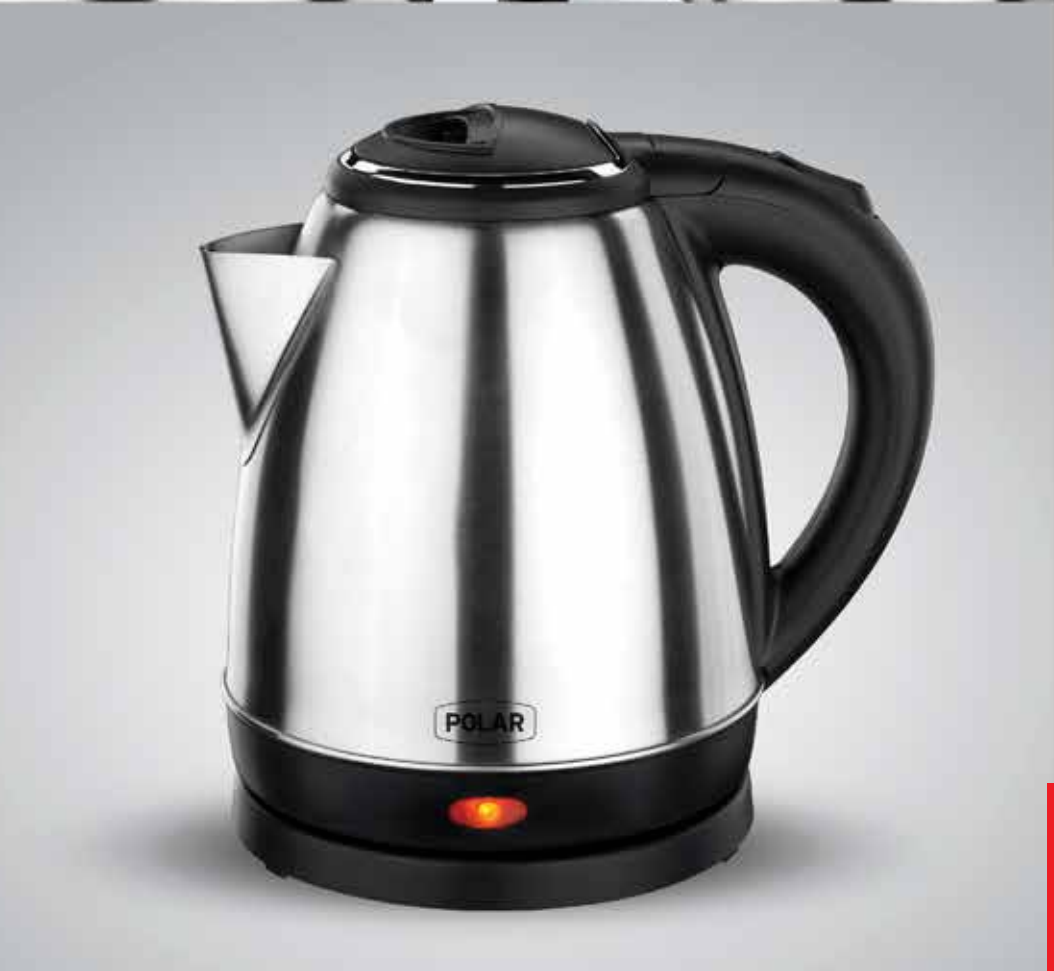

## GALAXY 1.5 SS | Electric Kettle



Neon ON  
Indicator

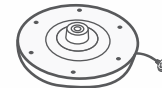

Cord Storage  
Facility



360° Cordless  
Operation



Pull  
Open Lid



Auto Shut-off  
Function



Stainless  
Steel Body



Capacity  
1.5 L

- Stylish design
- Rated power 1500 W
- Corrosion proof stainless steel body

**1** YEAR  
WARRANTY

# GALAXY 1.8 SS | Electric Kettle



Neon ON  
Indicator

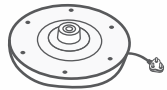

Cord Storage  
Facility



360° Cordless  
Operation



Pull  
Open Lid



Auto Shut-off  
Function



Stainless  
Steel Body



Capacity  
1.8 L

- Stylish design
- Rated power 1500 W
- Corrosion proof stainless steel body

**1** YEAR  
WARRANTY



UPGRADE YOUR  
CULINARY SKILLS  
IN STYLE

---



INDUCTION  
COOKER



## CM 11 | Induction Cooker



LED Digital Display



Overheat Protection



Push Button Control



Child Safety Lock



Auto Safety Shut-off



Multiple Heat Settings



Rated Power 1600 W



ISI Approved

- Automatic voltage regulator
- Quick heating
- 7 preset menu



**1** YEAR  
WARRANTY



# CM 12 | Induction Cooker



Digital Timer Control



Overheat Protection



Touch Button Control



Fully Polished Glass Top



Auto Safety Shut-off

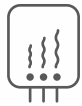

Multiple Heat Settings



Rated Power 2000 W



ISI Approved

- Automatic voltage regulator
- Quick heating
- 8 preset menu

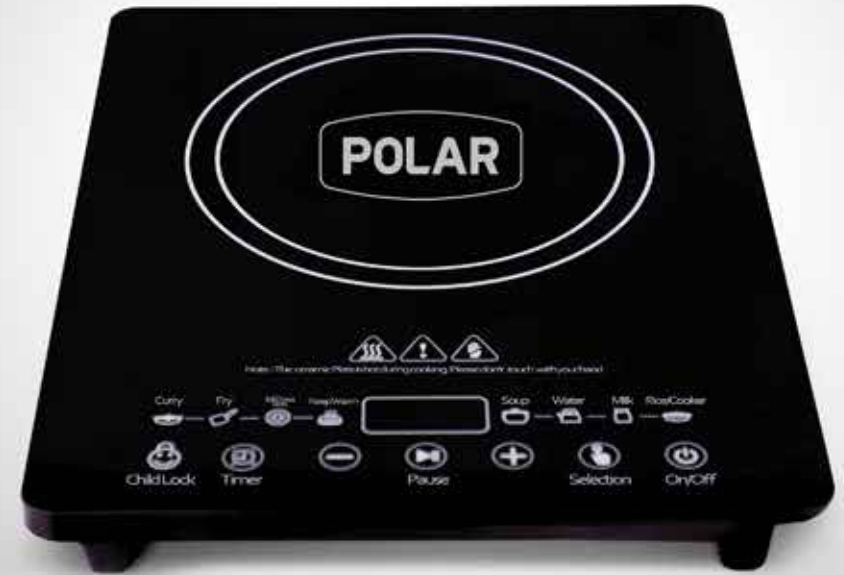

**1** YEAR  
WARRANTY



# SMART COOK SC-01 | Infrared Cooker



4-hour  
Smart Timer



3 Preset  
Functions



Overheat  
Protection



Extra Wide  
Cooking Surface



Temperature  
Control Knob



4-digit Bright  
LED Display



Easy to  
Clean



Feather  
Touch Control

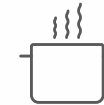

Use All Kinds of  
Flat Utensils



Sturdy Stainless  
Steel Body  
& Handle



High-temperature  
Resisting  
Crystal Plate



Versatile  
Cooking  
Solution



Rated Power  
2000 W

- 3 preset functions
- 4-digit bright LED display
- Sturdy stainless steel body & handle

**2** YEARS  
WARRANTY





# SMART COOK SC-02 | Infrared Cooker



3-hour  
Smart Timer



4 Preset  
Functions



Overheat  
Protection



Extra Wide  
Cooking Surface



Temperature  
Control Knob



4-digit Bright  
LED Display



Easy to  
Clean



Feather  
Touch Control

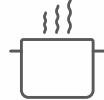

Use All Kinds of  
Flat Utensils



Sturdy Stainless  
Steel Body  
& Handle



High-temperature  
Resisting  
Crystal Plate



Versatile  
Cooking  
Solution



Rated Power  
2000 W

- 4 preset functions
- 4-digit bright LED display
- Sturdy stainless steel body & handle

**2** YEARS  
WARRANTY



ELECTRIC  
IRON

---

LOOK GOOD  
EFFORTLESSLY

---



# 1000H1 | Electric Dry Iron



Heavyweight  
(1.5 Kg)

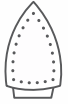

Non-stick  
PTFE Coated  
Soleplate



Multiple  
Temperature  
Settings



360°  
Swivel Cord



Thermostat  
with Safety  
Fuse



Rated Power  
1000 W



ISI  
Approved

- Bimetallic thermostat for automatic temperature control
- Cool touch handle with comfortable grip
- Super clean surface finish with pleasant aesthetics
- Ideal for heavy-duty pressing
- Multiple temperature settings for different fabrics

**2** YEARS REPLACEMENT  
WARRANTY





## 1000P6 | Electric Dry Iron



Ultra  
Lightweight



Non-stick  
PTFE Coated  
Soleplate



Multiple  
Temperature  
Settings



360°  
Swivel Cord



Thermostat  
with Safety  
Fuse



Rated Power  
1000 W



ISI  
Approved

- Ergonomic design with bi-colour combo
- Instant heating & powerful performance
- Bimetallic thermostat for automatic temperature control
- Reliable snap-action thermostat
- Multiple temperature settings for different fabrics
- Ultra lightweight cool touch body

**2** YEARS REPLACEMENT  
WARRANTY





## 1000P7 | Electric Dry Iron



Ultra  
Lightweight



Non-stick  
PTFE Coated  
Soleplate



Multiple  
Temperature  
Settings



360°  
Swivel Cord



Thermostat  
with Safety  
Fuse



Rated Power  
1000 W



ISI  
Approved

- Ergonomic design with bi-colour combo
- Instant heating & powerful performance
- Bimetallic thermostat for automatic temperature control
- Reliable snap-action thermostat
- Multiple temperature settings for different fabrics
- Ultra lightweight cool touch body

**2** YEARS REPLACEMENT  
WARRANTY



## 1000M7 | Electric Dry Iron



Heavy-duty  
Lightweight



Non-stick  
PTFE Coated  
Soleplate



Multiple  
Temperature  
Settings



360°  
Swivel Cord



Thermostat  
with Safety  
Fuse



Rated Power  
1000 W



ISI  
Approved

- Heavy-duty lightweight metal body
- Bimetallic thermostat for automatic temperature control
- Cool touch handle with comfortable grip
- Super clean surface finish with pleasant aesthetics & tangle-free cord
- Multiple temperature settings for different fabrics

**2** YEARS REPLACEMENT  
WARRANTY





## 750M2 | Electric Dry Iron



Heavy-duty  
Lightweight



Non-stick  
PTFE Coated  
Soleplate



Multiple  
Temperature  
Settings



360°  
Swivel Cord



Thermostat  
with Safety  
Fuse



Rated Power  
750 W



ISI  
Approved

- Heavy-duty lightweight metal body
- Bimetallic thermostat for automatic temperature control
- Cool touch handle with comfortable grip
- Super clean surface finish with pleasant aesthetics & tangle-free cord
- Multiple temperature settings for different fabrics

**2** YEARS REPLACEMENT  
WARRANTY

SANDWICH  
MAKER

---

PUT TOGETHER  
A MOUTH-  
WATERING  
SNACK  
INSTANTLY

---



# GALAXY | Sandwich Maker



Non-stick  
Heating Plate



Deeper  
Pockets



Overheat  
Protection



Broad  
Hand Lock



Dual LED  
Indicators



Rated Power  
750 W



ISI  
Approved

- Non-stick heating plate for oil free toasting
- Powerful performance & faster heating with 750 W rated power
- Deeper pockets for extra filling in every sandwich
- Heat-resistant bakelite body for cool touch operation
- Overheat protection with thermal fuse
- Broad hand lock for easy & comfortable locking
- Dual LED indicators for easy & convenient usage

**1** YEAR  
WARRANTY



ROOM  
HEATER

---

A PLEASANT  
ATMOSPHERE IN  
EVERY CORNER





# COMFORT

## Halogen Heater



3 Halogen Heating Elements



Rust-free Stainless Steel Reflector



3 Heat Settings



Safety Mesh Grille

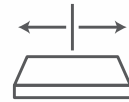

Wider Base for Better Stability



Wider Angle Oscillation



Long-lasting Uniform Heating



Heat-resistant Plastic Body



Safety Tip-over Switch



ISI Approved

- Very elegant look with a wide base
- Cool touch body
- 3 heat settings – 400/800/1200 W
- Rated power – 400/800/1200 W

**1** YEAR  
WARRANTY



# LAVA | Quartz Heater



Quartz Tube Heating Element



Rust-free Stainless Steel Reflector



Safety Mesh Grille



Dual Heating Power Settings



Long-lasting Uniform Heating



Heat-resistant Plastic Body



Safety Tip-over Switch



Rated Power 400/800 W



ISI Approved



- Highly efficient quartz tube heating element
- Slim & sleek design
- Dual heating power settings – 400 W & 800 W

**1** YEAR  
WARRANTY





# HOTWAVE | Quartz Heater



Quartz Tube Heating Element



Rust-free Stainless Steel Reflector



Safety Mesh Grille



Cool Touch Body



Dual Heating Power Settings



Heat-resistant Plastic Body



Easy to Carry



Safety Tip-over Switch



Rated Power 400/800 W



ISI Approved

- Highly efficient quartz tube heating element
- Slim & sleek design
- Dual heating power settings – 400 W & 800 W



**1** YEAR  
WARRANTY



## LAVA+ | Quartz Heater



Quartz Tube Heating Element



Rust-free Stainless Steel Reflector



Safety Mesh Grille



Cool Touch Body



Dual Heating Power Settings



Long-lasting Uniform Heating



Heat-resistant Plastic Body



Safety Tip-over Switch



Rated Power 400/800 W



ISI Approved



- Highly efficient quartz tube heating element
- Slim & sleek design
- Dual heating power settings – 400 W & 800 W

**1** YEAR  
WARRANTY



## VISTRON | Heat Convector



Dual Heating Positions



Twin Turbo Fans



Safety Thermal Cut-out



Cool Touch Handle for Easy Movement



Temperature Control



Adjustable Height



Rated Power 1000/2000 W



ISI Approved



- Modern & sleek design
- Dual heating positions for better heating – low (1000 W) & high (2000 W)
- Sturdy body
- Night lamp indicator
- Twin turbo fans for uniform heating

**1** YEAR  
WARRANTY



## LAVA | Fan Heater



Two Heat Positions



Safety Thermal Cut-out



Cool Airflow



Heat-resistant Plastic Body



Rated Power 1000/2000 W



ISI Approved

- Two heat positions for better heating
- Cool airflow for summer use
- Pilot light
- Portable design
- Childproof grille
- Heat-resistant & shock-proof plastic body

**1** YEAR  
WARRANTY





# GLEAM | Ceramic Heater



Anti-corrosion  
Powder Coated  
Body



Nickel Chrome  
Plated Mesh  
Guard



Rust-free  
Stainless Steel  
Reflector



Quick & Efficient  
Heating



Rated Power  
1000 W



ISI  
Approved



- Compact & stylish design
- Energy-efficient

**2** YEARS  
WARRANTY

PLUG IN YOUR  
ELECTRONICS WITHOUT  
MOVING AN INCH

---



EXTENSION REEL &  
SURGE PROTECTOR

---



# EXTENSION REEL

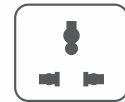

Universal  
Connector Port



Master  
Switch with  
LED Indicator



360° Smooth  
Rotation



Rated Power  
1500 VA



4 Metres Long  
High-quality  
Cable

- 4 metres long high-quality cable for extended reach





# SURGE PROTECTOR

---

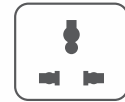

Universal  
Connector Port



Single Power  
Switch



LED  
Indicator



Rated Power  
1500 VA



High-quality  
Cable



Heat-resistant  
Body



Voltage  
Fluctuation  
Protector

- 
- Manages load up to 1.5 kW
  - Cord length variants – 1.5, 2 & 2.5 metres

# INSTALLATION DIAGRAM

WATER HEATER

## Aquahot

\*Mounting Dimension's Tolerance is  $\pm 1\%$

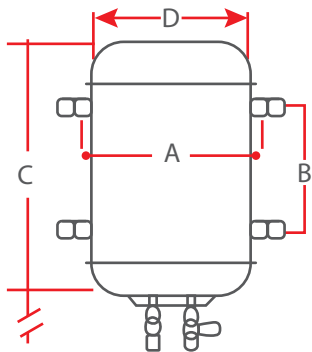

Vertical Mounting

### Mounting Dimensions

Model	Capacity	Mounting	Mounting dimensions in mm			
			A	B	C	D
Aquahot	6 L	Vertical	195	130	325	255
	10 L	Vertical	195	175	375	255
	15 L	Vertical	215	215	405	305
	25 L	Vertical	215	220	450	355
	35 L	Vertical	285	260	500	380
	50 L	Vertical	290	385	620	420

## Gush & Marbella

\*Mounting Dimension's Tolerance is  $\pm 1\%$

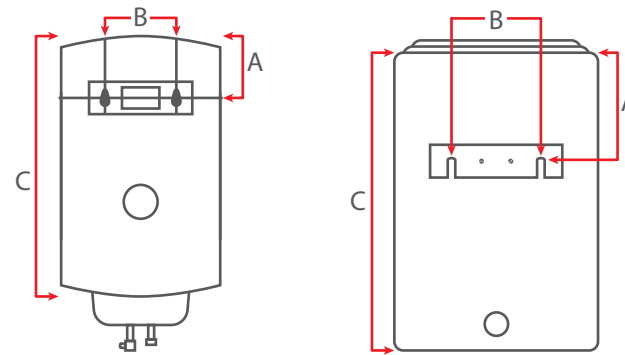

Gush

Marbella

### Mounting Dimensions

Model	Capacity	Mounting	Mounting dimensions in mm		
			A	B	C
Gush	6 L	Vertical	75	175	324
	10 L	Vertical	80	175	333
	15 L	Vertical	156	175	433
	25 L	Vertical	122	175	496
	Marbella	10 L	Vertical	165	175
Marbella	15 L	Vertical	190	175	495
	25 L	Vertical	185	175	535

# INSTALLATION DIAGRAM

WATER HEATER

## Lava

\*Mounting Dimension's Tolerance is  $\pm 1\%$

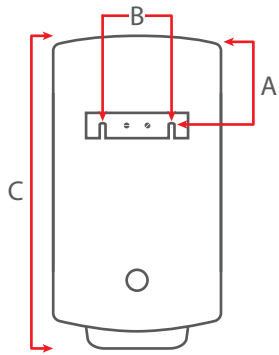

Lava Vertical

### Mounting Dimensions

Model	Capacity	Mounting	Mounting dimensions in mm		
			A	B	C
Lava	10 L	Vertical	80	175	333
	15 L	Vertical	156	175	433
	25 L	Vertical	122	175	496

## Lava+

\*Mounting Dimension's Tolerance is  $\pm 1\%$

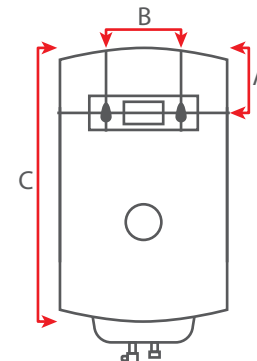

Lava+ Vertical

### Mounting Dimensions

Model	Capacity	Mounting	Mounting dimensions in mm		
			A	B	C
Lava+	10 L	Vertical	80	175	333
	15 L	Vertical	156	175	433
	25 L	Vertical	122	175	496

# INSTALLATION DIAGRAM

WATER HEATER

## Legacy+

\*Mounting Dimension's Tolerance is  $\pm 1\%$

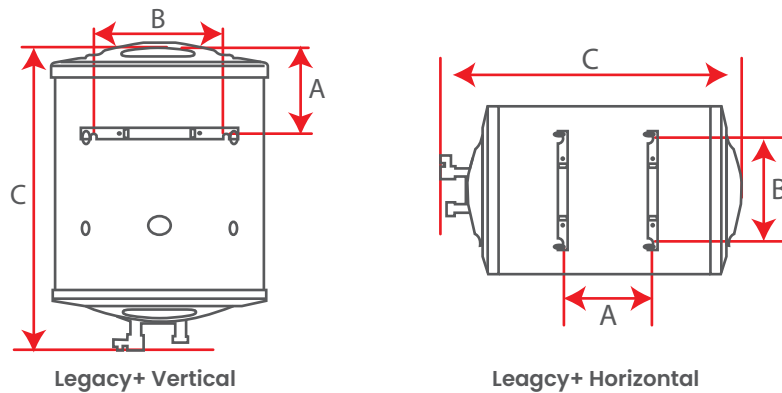

### Mounting Dimensions

Model	Capacity	Mounting	Mounting dimensions in mm		
			A	B	C
Legacy+	6 L	Vertical	150	222	415
	10 L	Vertical	150	222	475
	15 L	Vertical	190	222	550
	25 L	Vertical	220	222	600
	15 L	Horizontal	240	180	320
	25 L	Horizontal	240	215	370

## Freshet

\*Mounting Dimension's Tolerance is  $\pm 1\%$

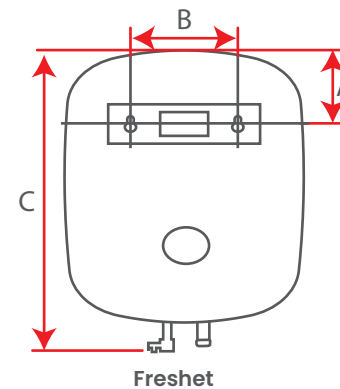

### Mounting Dimensions

Model	Capacity	Mounting	Mounting dimensions in mm		
			A	B	C
Freshet	6 L	Vertical	150	175	355
	10 L	Vertical	200	180	500
	15 L	Vertical	185	180	510
	25 L	Vertical	185	180	580



## BRANCHES

### SOUTH

Chennai +91 89398 96009, bmmads@polarelectric.in | Madurai +91 72990 33418, bmmad@polarelectric.in  
Kochi +91 62922 59196, bmcoc@polarelectric.in | Bengaluru +91 91471 05489, bmbng@polarelectric.in  
Vijayawada +91 76050 83472, bmvij@polarelectric.in | Hyderabad 90739 55030, bmhyd@polarelectric.in

### EAST

Kolkata +91 62922 59198, bmkol@polarelectric.in | Bhubaneswar +91 90739 54614, bmbbs@polarelectric.in  
Guwahati +91 90739 54651, bmguw@polarelectric.in | Patna +91 62923 11682, bmptn@polarelectric.in  
Ranchi +91 62923 05911, bmrnc@polarelectric.in

### NORTH

Delhi +91 90739 54778, bmdel@polarelectric.in | Chandigarh (0172) 507 7258/90739 54765, bmchd@polarelectric.in  
Jaipur (0141) 403 6715/90510 56567, bmjpr@polarelectric.in | Kanpur +91 90739 54616, bmknk@polarelectric.in  
Ghaziabad +91 62923 17385, bmgzb@polarelectric.in | Dehradun +91 62922 65331, bmddn@polarelectric.in  
Varanasi +91 62922 97887, bmvns@polarelectric.in

### WEST & CENTRAL

Mumbai (02522) 661 973/90739 55042, bmmum@polarelectric.in | Ahmedabad +91 76040 35557, bmahm@polarelectric.in  
Indore +91 91471 32821, bmind@polarelectric.in | Raipur +91 90739 54648, bmrpr@polarelectric.in

### VISHVA ELECTROTECH LTD.

CIN: U31501WB2009PLC132426 (Licensed user of POLAR Trade Mark)

Regd. Off.: Unit No. 8B & 8C, 8th Floor, 23 Circus Avenue, Kolkata 700 017, West Bengal, India



Makes life easy

- 📞 (033) 6629 1829
- ✉️ [customercare@polarelectric.in](mailto:customercare@polarelectric.in) | [info@polarelectric.in](mailto:info@polarelectric.in)
- 🌐 [www.polarelectric.in](http://www.polarelectric.in)
- 📘 [www.facebook.com/PolarIndia](https://www.facebook.com/PolarIndia)

**Customer Care**  
**033 6100 6100**

---

We at Polar, have a policy of continuous improvements. Hence, product specifications and aesthetics may change without prior notice.