



POLAR

Makes life easy

About Us

POLAR

An experience of more than four decades, with expertise in connecting innovation to comfort, has enabled Polar to create an empire of hassle-free living for generations. With a versatile range of fans designed with ground-breaking technology and elegance, Polar has successfully made a mark in multiple sectors, including homes, offices and other commercial spaces. What makes Polar stand apart is its ceaseless performance and seamless service. Today millions of homes in India are powered with the privilege of ultimate comfort promised by Polar.



BEAT THE HEAT WITH THE COOLEST OPTIONS



Want to
save energy?

Best options are on pages

01 _____ 16

Looking for
a premium
upgrade?

Choose from pages

17 _____ 32

If performance
is all you
care about,

ideal options are on pages

33 _____ 70

Want to tackle
heat smartly?

Choose from pages

71 _____ 114

Small
space?

Ideal options are on pages

115 _____ 122

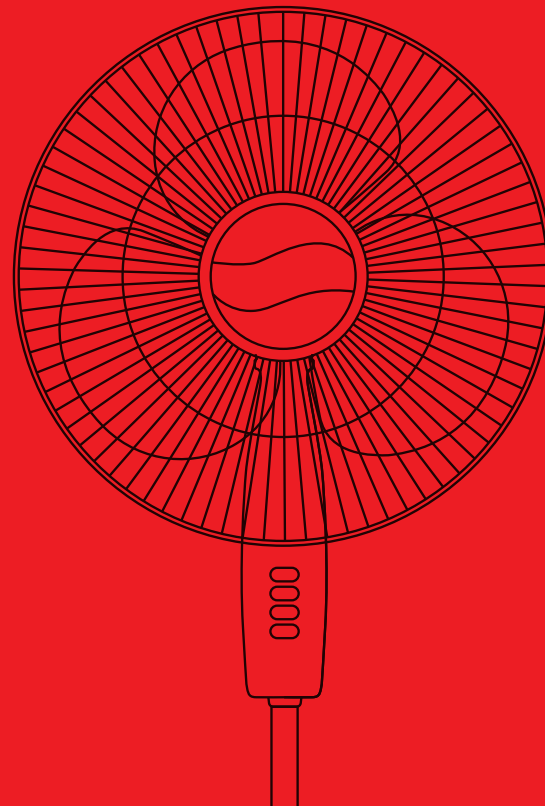

If you want
odourless
indoors,

choose from pages

123 _____ 128

Make large
spaces
comfortable,

with options from pages

129 _____ 136

SAVE POWER IN A COOL WAY



03

GOLDEN DUNE

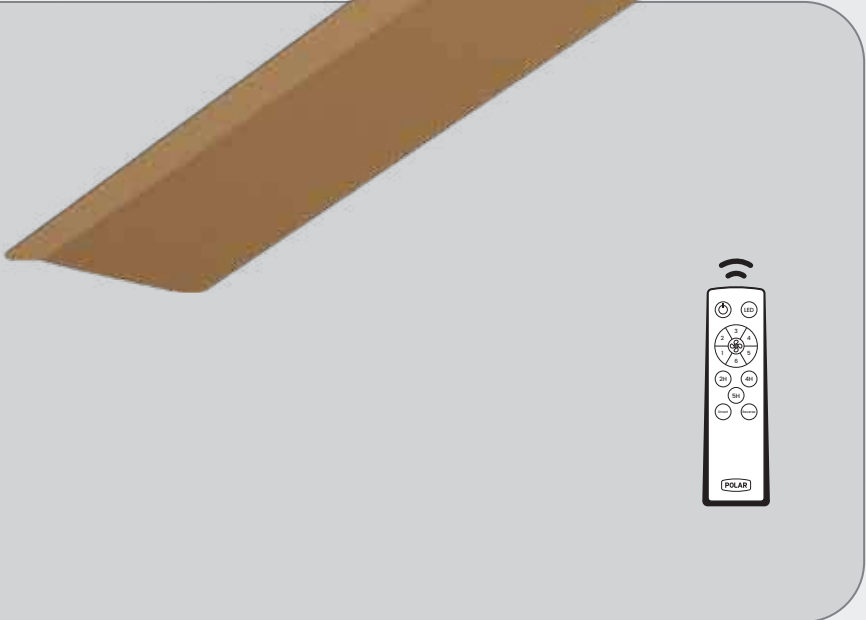

EFISLIM

Super Energy-saving Fan





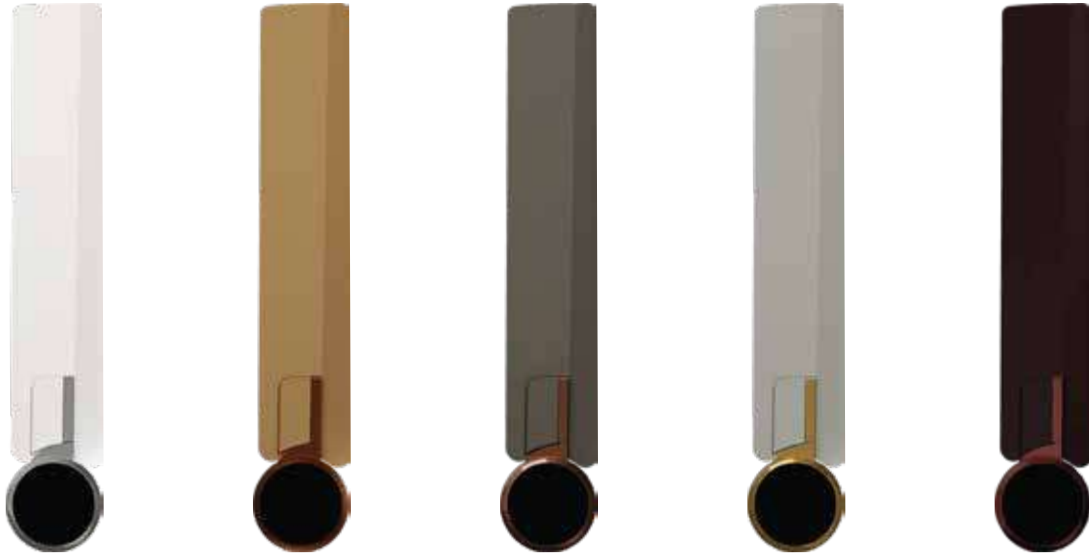

3 YEARS WARRANTY



PEARL WHITE	GOLDEN DUNE	TITANIUM GREY	SILVER	BAKER BROWN
-------------	-------------	---------------	--------	-------------

Features

-  Powerful BLDC motor with 60% power savings
-  Remote controller for speed regulation
-  Contemporary slim design for modern homes
-  Aerodynamically designed blades for high air delivery

- Wide operational voltage with fluctuation protection (150 V to 260 V)



TECHNICAL SPECIFICATIONS	Sweep in mm	Power Input in Watts	Speed in RPM	Air Delivery in CMM	Service Value in CMM/Watts
	1200	32	350	225	7

GOLDEN DUNE



WINLITE

Super Energy-saving Fan







2 YEARS WARRANTY



GOLDEN DUNE	PEARL WHITE	PEARL BROWN	TITANIUM GREY	INDIGO BLUE
-------------	-------------	-------------	---------------	-------------

Features

-  Powerful BLDC motor with 60% power savings
-  Contemporary LED under light
-  Remote controller for speed regulation and light ON/OFF
-  Aerodynamic designed ribbed blades for high air delivery

- Wide operational voltage with fluctuation protection (150 V to 260 V)

TECHNICAL SPECIFICATIONS

Sweep in mm	Power Input in Watts	Speed in RPM	Air Delivery in CMM	Service Value in CMM/Watts
1200	32*	350	220	6.9

*with light – 38 W



BAKER BROWN-GOLD



PROLIFIC

Super Energy-saving Fan



5 YEARS WARRANTY



BAKER BROWN-GOLD	LIGHT BLUE-SILVER	PEARL BROWN-GOLD	TITANIUM SILVER	PEARL SILVER-GREY
---------------------	----------------------	---------------------	-----------------	----------------------

Features

-  BLDC motor with 60% power savings
-  230 CMM for wider air spread and thrust
-  RF remote can be operated from anywhere in the room
-  Elegant canopy with decorative shroud
-  Contemporary design complements modern décor

- Wide operational voltage with fluctuation protection (150 V to 260 V)



TECHNICAL SPECIFICATIONS	Sweep in mm	Power Input in Watts	Speed in RPM	Air Delivery in CMM	Service Value in CMM/Watts
	1200	32	350	230	7.1

09

BROWN

EFICO PRO

Super Energy-saving Fan

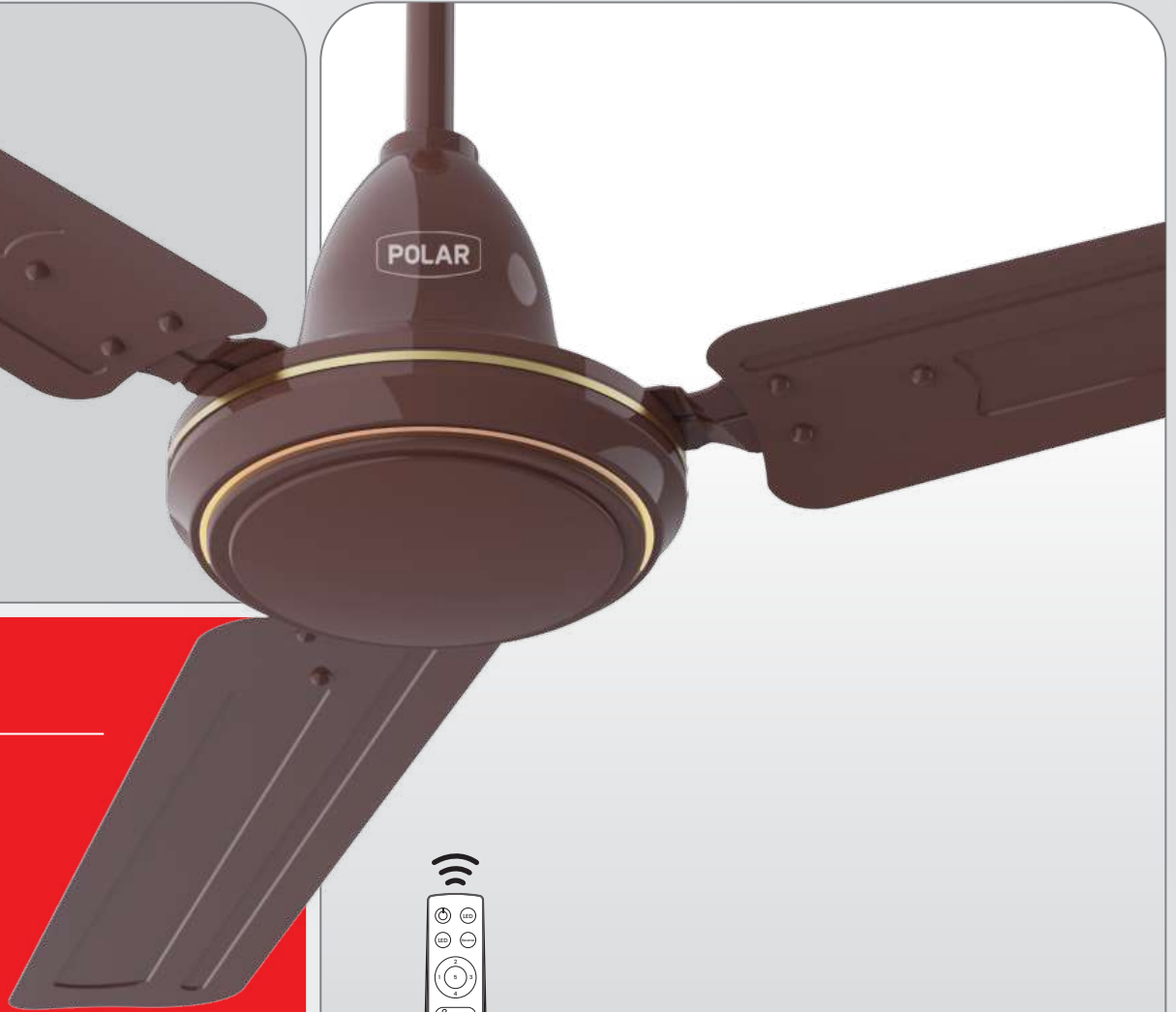

2 YEARS WARRANTY



BROWN



WHITE



IVORY

Features



BLDC motor with 65% power savings



High-performance long-life motor



Lightweight aluminium blades for excellent air delivery



RF remote can be operated from anywhere in the room

- Wide operational voltage with fluctuation protection (150 V to 260 V)



TECHNICAL SPECIFICATIONS

Sweep in mm
1200

Power Input in Watts
26

Speed in RPM
350

Air Delivery in CMM
210

Service Value in CMM/Watts
8

IVORY

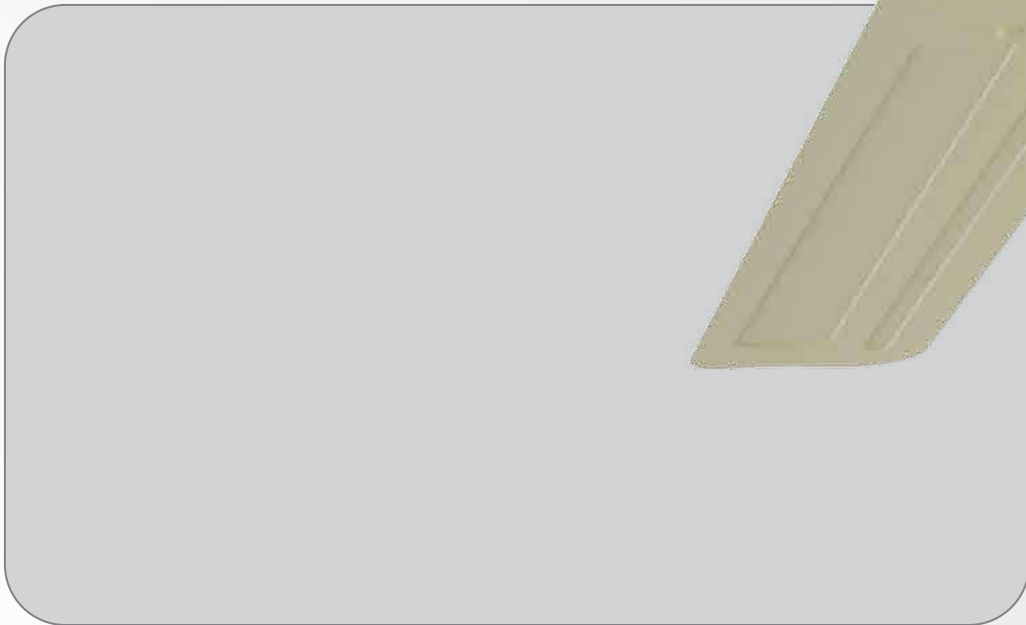

EFICO

Super Energy-saving Fan



2 YEARS WARRANTY



BROWN



WHITE



IVORY

Features



BLDC motor with 65% power savings



High-performance long-life motor



Aerodynamically designed ribbed blades for high air thrust



Works with regular capacitor-type step regulator only

- Wide operational voltage with fluctuation protection (150 V to 260 V)



TECHNICAL SPECIFICATIONS

Sweep in mm
1200

Power Input in Watts
26

Speed in RPM
350

Air Delivery in CMM
210

Service Value in CMM/Watts
8

BROWN



PS-32

Super Energy-saving Fan



2 YEARS WARRANTY



BROWN

WHITE

IVORY

Features

 BLDC motor with 60% power savings

 220 CMM for high air delivery

 Remote controller for speed regulation

 Wider blade tips for high air thrust and spread

- Wide operational voltage with fluctuation protection (150 V to 260 V)



TECHNICAL SPECIFICATIONS

Sweep in mm
1200

Power Input in Watts
32

Speed in RPM
350

Air Delivery in CMM
220

Service Value in CMM/Watts
6.8

IVORY



PS-35

Super Energy-saving Fan



2 YEARS WARRANTY



BROWN

WHITE

IVORY

Features

 BLDC motor with 60% power savings

 245 CMM for high air delivery

 Remote controller for speed regulation

 Wider blade tips for high air thrust and spread

- Wide operational voltage with fluctuation protection (150 V to 260 V)



TECHNICAL SPECIFICATIONS

Sweep in mm
1400

Power Input in Watts
35

Speed in RPM
310

Air Delivery in CMM
245

Service Value in CMM/Watts
7

Premium Fans

**BREEZE WITH
A LUXURIOUS
FEEL**

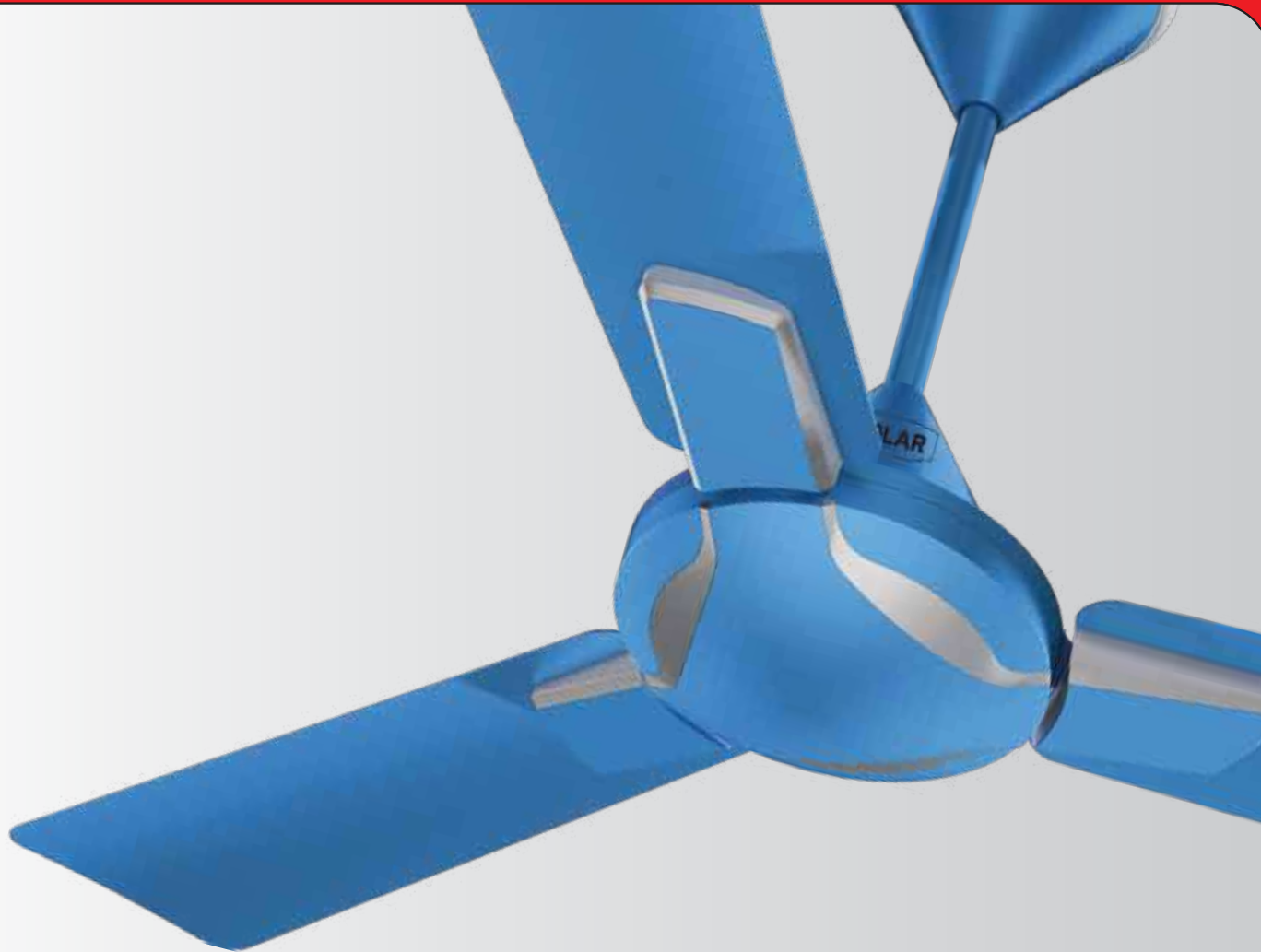

TOPAZ

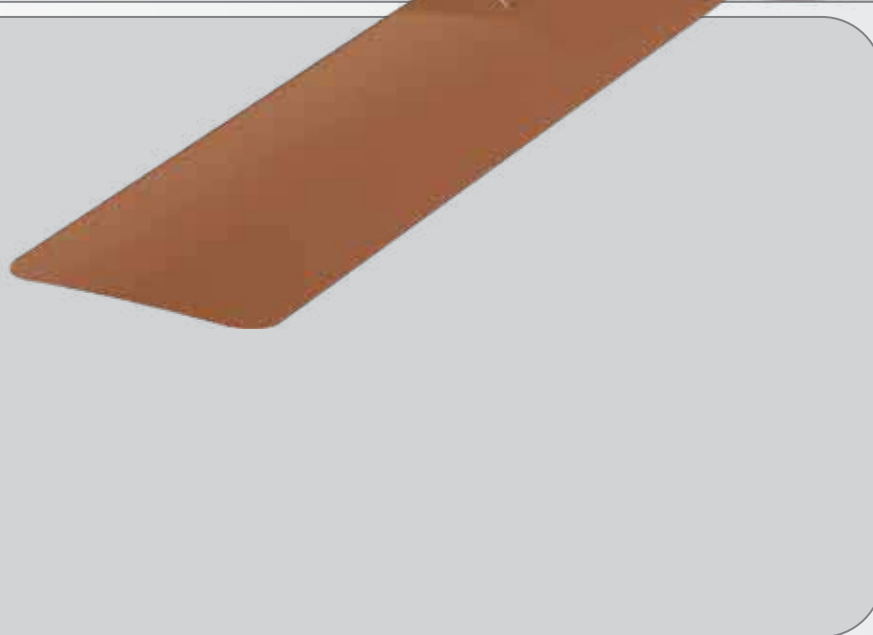

EFISAVY ANTI-DUST

Energy-saving Fan







3 YEARS WARRANTY



MAYA BLUE	ANGEL WHITE	CARBON BLACK	TITANIUM GREY	PLUM BROWN	TOPAZ
-----------	-------------	--------------	---------------	------------	-------

Features

-  Powerful & energy-efficient 100% copper motor
-  225 CMM for wider air spread & high thrust
-  Wide range of lustrous metallic paints to suit every style
-  Wide aluminium blades for high air delivery
-  Anti-dust coating to ensure minimal dust deposition & easy cleaning

- Contemporary designer fans that are energy-efficient



TECHNICAL SPECIFICATIONS	Sweep in mm	Power Input in Watts	Speed in RPM	Air Delivery in CMM	Service Value in CMM/Watts
	1200	53	360	225	4.2

LIGHT BLUE-SILVER

PROLIFIC

Energy-saving Fan



2 YEARS WARRANTY

Features



-  230 CMM for high air delivery
-  Elegant canopy with decorative shroud
-  Contemporary design complements modern décor
-  Uniquely designed blades for high air delivery

BAKER BROWN-GOLD	LIGHT BLUE-SILVER	PEARL BROWN-GOLD	TITANIUM SILVER	PEARL SILVER-GREY
------------------	-------------------	------------------	-----------------	-------------------

- Two-tone metallic paint combination for enriched aesthetics
- Contemporary design with multi-colour options



TECHNICAL SPECIFICATIONS	Sweep in mm	Power Input in Watts	Speed in RPM	Air Delivery in CMM	Service Value in CMM/Watts
	1200	53	360	230	4.3

PEARL IVORY-METALLIC
BROWN

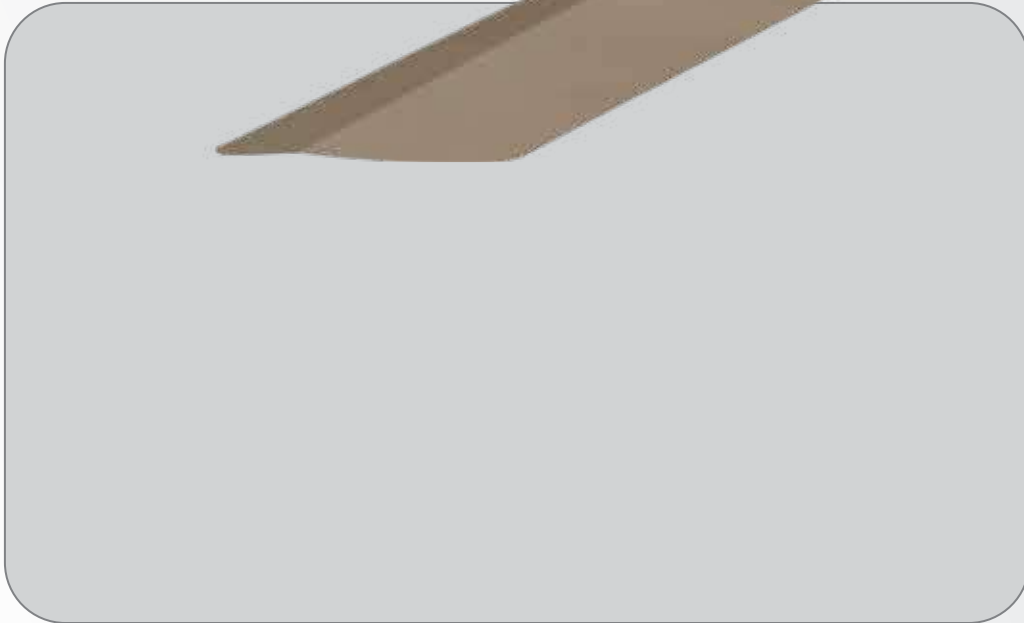

CORVETTE ANTI-DUST

Energy-saving Fan







2 YEARS WARRANTY



PEARL IVORY-METALLIC BROWN	BAKER BROWN-GOLD	INDIGO BLUE-SILVER	PEARL SILVER-INDIGO BLUE	BIRKEN GOLD-BROWN	TITANIUM SILVER
----------------------------------	---------------------	-----------------------	--------------------------------	----------------------	-----------------

Features

-  Energy-efficient motor with excellent design for optimum low voltage operation
-  220 CMM for wider air spread and high thrust
-  Wider blade tips for high air thrust and spread
-  Annular deco ring on motor periphery complements modern home décor

- Anti-dust coating to ensure minimal dust deposition and easy cleaning
- Metallic paint with multi-colour options complements modern luxurious homes

TECHNICAL SPECIFICATIONS

Sweep in mm	Power Input in Watts	Speed in RPM	Air Delivery in CMM	Service Value in CMM/Watts
1200	53	360	220	4.2



COBALT BLUE

CORVETTE CORE

Energy-saving Fan



2 YEARS WARRANTY



COBALT BLUE	RUSTY COPPER	ELEPHANT GREY	WHITE	BROWN	IVORY
-------------	--------------	---------------	-------	-------	-------

Features

-  Powder coated to ensure long-lasting attractive finish
-  220 CMM for wider air spread and high thrust
-  Wider blades for high air thrust and spread
-  Contemporary design for modern homes

- Annular deco ring on motor periphery
- Energy-efficient motor with optimum design for high air delivery

TECHNICAL SPECIFICATIONS

Sweep in mm	Power Input in Watts	Speed in RPM	Air Delivery in CMM	Service Value in CMM/Watts
1200	53	360	220	4.2



GOLDEN DUNE

WINAIRE++

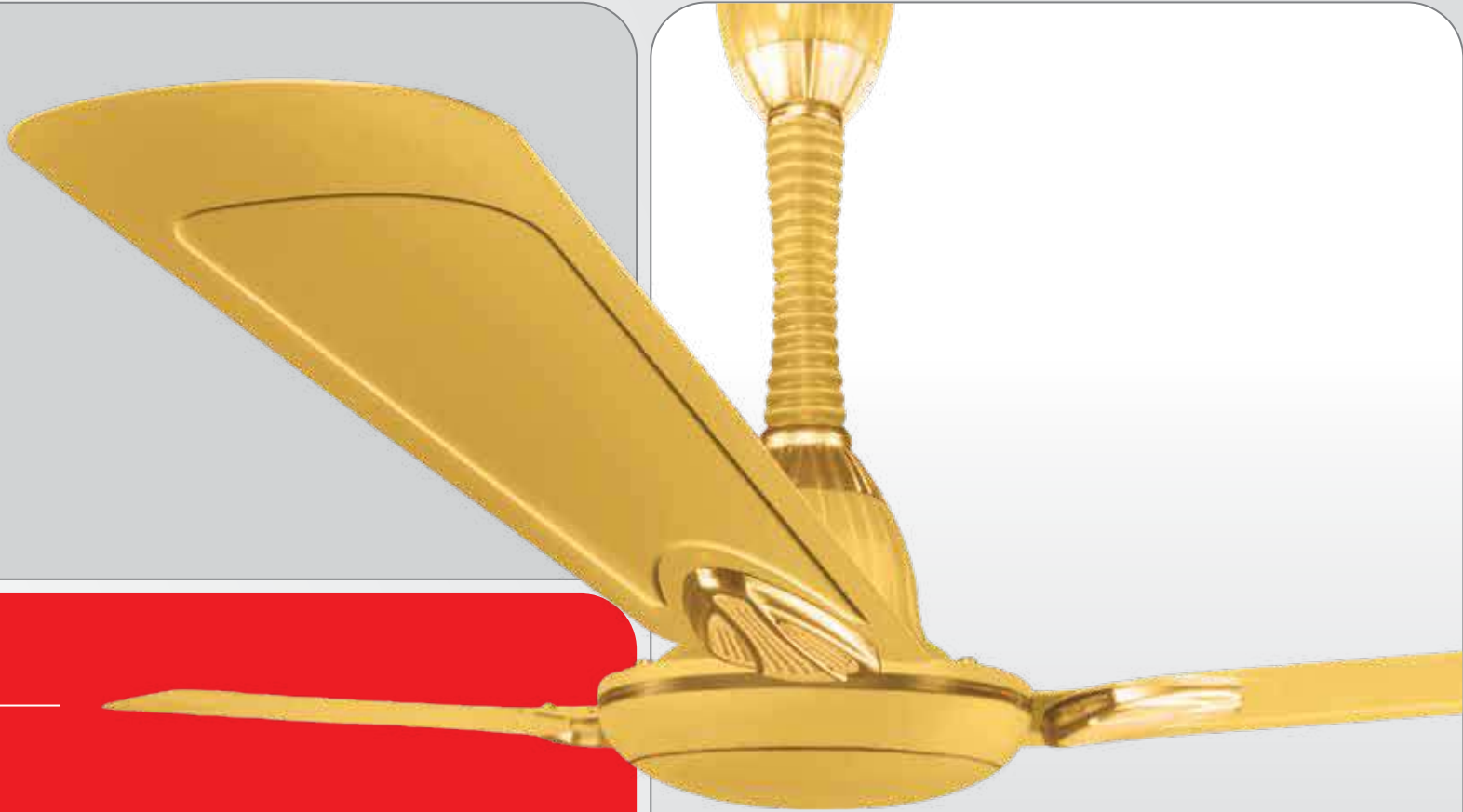

Energy-saving Fan



2 YEARS WARRANTY

Features



-  Powerful & energy-efficient motor with 100% copper winding
-  30% wider blade tips for higher speed
-  Classic and elegant design complements home décor

CAPPUCCINO	WONDER WHITE	HUSKY GOLD	TITANIUM	ROYAL PINK	PEARL IVORY	GOLDEN DUNE	ROYAL CHAMPAGNE
------------	--------------	------------	----------	------------	-------------	-------------	-----------------

- Metallic paint finish with lacquer coating for longer life
- Wide range of colours for stylish and modern homes

TECHNICAL SPECIFICATIONS

Sweep in mm	Power Input in Watts	Speed in RPM	Air Delivery in CMM	Service Value in CMM/Watts
900	40	425	130	3.3
1200	53	360	220	4.2



TOPAZ



WINPRO MX ANTI-DUST

Energy-saving Fan





4 YEARS WARRANTY

Features



TOPAZ	BURGUNDY	CARAMEL GOLD	PEARL WHITE	BLACK	METALLIC COPPER
-------	----------	--------------	-------------	-------	-----------------

 220 CMM for high air delivery

 Powerful and energy-efficient motor with 100% copper winding

 Wide aluminium blades for high air spread and thrust

- Anti-dust coating ensures minimal dust deposition and keeps the fan stain-free
- Metallic paint finish

TECHNICAL SPECIFICATIONS

Sweep in mm	Power Input in Watts	Speed in RPM	Air Delivery in CMM	Service Value in CMM/Watts
1200	53	360	220	4.2



GOLDEN DUNE

POLAR

WINSPIN

Energy-saving Fan





2 YEARS WARRANTY

Features



GOLDEN DUNE	BAKER BROWN	SMOKE BROWN	IVORY
-------------	-------------	-------------	-------

-  Powerful and energy-efficient 100% copper motor
-  Wide aluminium blades for high air thrust

- Aesthetically designed decorative ring and blade trims

TECHNICAL SPECIFICATIONS

Sweep in mm	Power Input in Watts	Speed in RPM	Air Delivery in CMM	Service Value in CMM/Watts
900	45	450	140	3.1
1200	55	360	220	4.0



**CEASELESS
BLISS**



BROWN

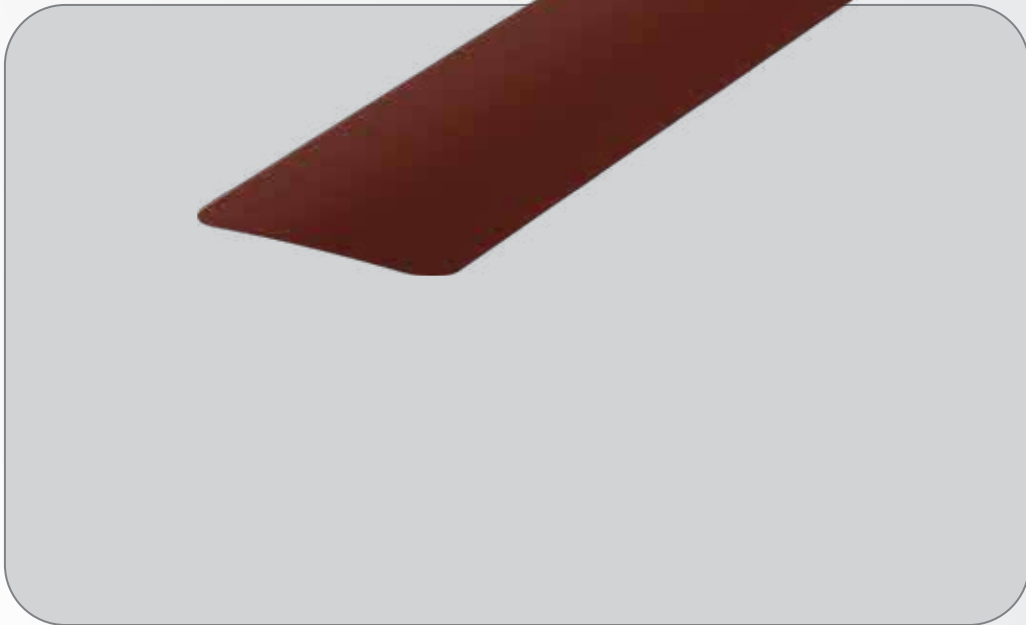

WINPRO STORM

Energy-saving Fan



4 YEARS WARRANTY



BROWN





IVORY



WHITE

Features

 230 CMM for wider air spread and high thrust

 Powerful & two star rated energy-efficient motor with 100% copper winding

 Wide aluminium blades for high air thrust

- Powder coated for longer life



TECHNICAL SPECIFICATIONS

Sweep in mm
1200

Power Input in Watts
51

Speed in RPM
360

Air Delivery in CMM
230

Service Value in CMM/Watts
4.5

MATT BROWN

SUPER SPEED

Energy-saving Fan



4 YEARS WARRANTY



MATT
IVORY

MATT
SILVER

MATT
BROWN

MATT
WHITE

Features

 220 CMM for high air delivery

 Powerful and energy-efficient motor with 100% copper winding

 Wider blade tips for excellent air delivery and thrust

- Minimalist design for modern homes



TECHNICAL SPECIFICATIONS

Sweep in mm	Power Input in Watts	Speed in RPM	Air Delivery in CMM	Service Value in CMM/Watts
1200	55	360	220	4.0

BROWN (DECO MODEL)



WINPRO

Energy-saving Fan





4 YEARS WARRANTY



BROWN (DECO MODEL)	BROWN (BASE MODEL)	IVORY (DECO MODEL)	IVORY (BASE MODEL)	WHITE (DECO MODEL)	WHITE (BASE MODEL)
-----------------------	-----------------------	-----------------------	-----------------------	-----------------------	-----------------------

Features

-  Powerful and energy-efficient motor with 100% copper winding
-  Wide aluminium blades for high air thrust
-  Deco model with super elegant two-part blade trims

- All-time favourite fan

TECHNICAL SPECIFICATIONS

Sweep in mm	Power Input in Watts	Speed in RPM	Air Delivery in CMM	Service Value in CMM/Watts
900	40	425	130	3.3
1200	55	360	220	4.0
1400	60	310	260	4.3



PEARL BROWN



WINSTYLE

Energy-saving Fan



2 YEARS WARRANTY

Features



PEARL BROWN	IVORY	SMOKE BROWN	TOPAZ
-------------	-------	-------------	-------



Powerful and energy-efficient 100% copper motor



Wide and aerodynamically designed blades for high air thrust

- Aesthetically designed decorative ring and blade trims

TECHNICAL SPECIFICATIONS

Sweep in mm
1200

Power Input in Watts
52

Speed in RPM
360

Air Delivery in CMM
210

Service Value in CMM/Watts
4.0



COBALT BLUE



RADIANT

Energy-saving Fan



2 YEARS WARRANTY



COBALT BLUE

ELEPHANT GREY

SMOKEY SILVER

RUSTY COPPER

Features



Powerful and energy-efficient motor with 100% copper winding



Unique ribbed blades for high air thrust



Decorative annular motor ring and contemporary blade trims

- Refreshing design in a range of colours

TECHNICAL SPECIFICATIONS

Sweep in mm

900
1200

Power Input in Watts

40
52

Speed in RPM

425
360

Air Delivery in CMM

132
210

Service Value in CMM/Watts

3.3
4.0



COBALT BLUE

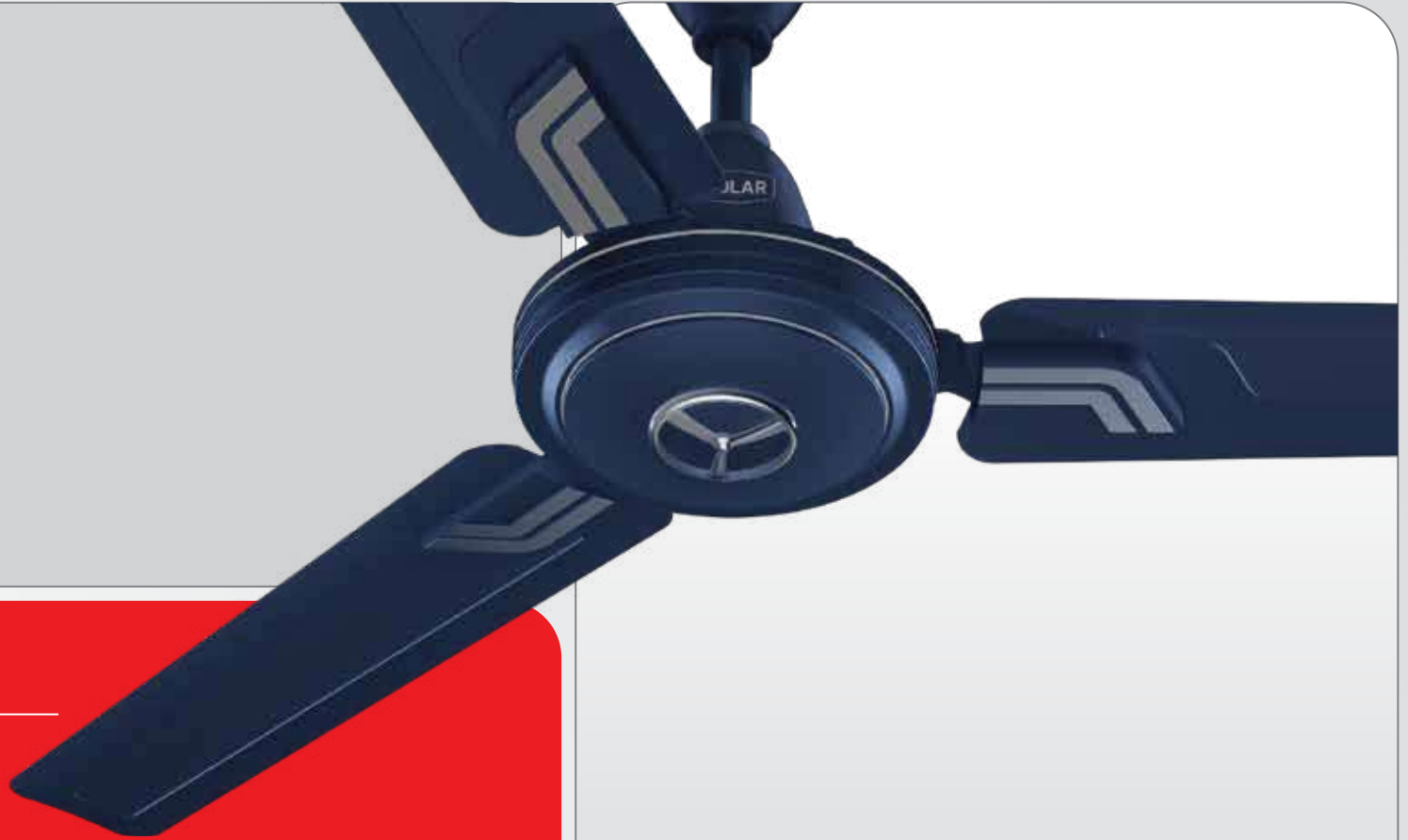

WINDCHILL

Energy-saving Fan





2 YEARS WARRANTY



COBALT BLUE	RUSTY COPPER	SMOKE BROWN	ELEPHANT GREY	WHITE
-------------	--------------	-------------	---------------	-------

Features

-  Powerful & energy-efficient motor with 100% copper winding
-  High-speed motor with 400 RPM
-  Aerodynamically designed ribbed blades for high air thrust

- Attractive colour range to elevate the style quotient of any home

TECHNICAL SPECIFICATIONS

Sweep in mm	Power Input in Watts	Speed in RPM	Air Delivery in CMM	Service Value in CMM/Watts
1200	52	400	210	4.0



IVORY



VINDURA

Energy-saving Fan







2 YEARS WARRANTY



SMOKE BROWN	RUSTY COPPER	COBALT BLUE	IVORY	GLOSSY BLACK
-------------	--------------	-------------	-------	--------------

Features

-  Powerful & energy-efficient motor
-  100% Copper winding motor for longer life
-  Unique ribbed blades for high air thrust
-  Decorative annular motor ring and contemporary blade trims

- Wide range of colours for stylish & modern homes



TECHNICAL SPECIFICATIONS	Sweep in mm	Power Input in Watts	Speed in RPM	Air Delivery in CMM	Service Value in CMM/Watts
	1200	52	360	210	4.0

CHAMPAGNE



MEGAMITE TT-DECO

Energy-saving Fan



2 YEARS WARRANTY



LIGHT
BLUE-SILVER



CHAMPAGNE

Features



Powerful and energy-efficient motor with 100% copper winding



Aerodynamically designed ribbed blades for high air thrust

- Two-tone metallic finish with bellow and bellow ring

TECHNICAL SPECIFICATIONS

Sweep
in mm

900
1200

Power Input
in Watts

40
50

Speed
in RPM

425
400

Air Delivery
in CMM

132
210

Service Value
in CMM/Watts

3.3
4.2





SMOKE BROWN

WINSTEEL

Energy-saving Fan



2 YEARS WARRANTY



MATT BLACK



SMOKE BROWN

Features



High-speed motor with 400 RPM



Powerful and energy-efficient motor with 100% copper winding



Unique ribbed blades for high air thrust and spread



Decorative annular ring on motor

- Powder coated for longer life



TECHNICAL SPECIFICATIONS

Sweep in mm
1200

Power Input in Watts
50

Speed in RPM
400

Air Delivery in CMM
210

Service Value in CMM/Watts
4.2

RUSTY COPPER



COMMANDER

Energy-saving Fan



2 YEARS WARRANTY



ELEPHANT
GREY



RUSTY
COPPER



WHITE

Features



Powerful motor
with 100% copper
winding



Aerodynamically
designed wide blades
for high air thrust

- Robust fan with excellent performance



**TECHNICAL
SPECIFICATIONS**

Sweep
in mm
1200

Power Input
in Watts
52

Speed
in RPM
360

Air Delivery
in CMM
210

Service Value
in CMM/Watts
4.0

BROWN (DECO MODEL)



PAVILION



Energy-saving Fan



2 YEARS WARRANTY

Features



-  Powerful and energy-efficient motor
-  Aerodynamically designed broad ribbed blades for high air thrust
-  Elegant look with high performance

BROWN (DECO MODEL)	BROWN (BASE MODEL)	IVORY (DECO MODEL)	IVORY (BASE MODEL)	WHITE (DECO MODEL)	WHITE (BASE MODEL)
-----------------------	-----------------------	-----------------------	-----------------------	-----------------------	-----------------------

- Available in base & deco models (Deco model available in 1200 mm sweep)

TECHNICAL SPECIFICATIONS

Sweep in mm	Power Input in Watts	Speed in RPM	Air Delivery in CMM	Service Value in CMM/Watts
900	40	425	132	3.3
1200	52	360	210	4.0



BROWN (DECO MODEL)

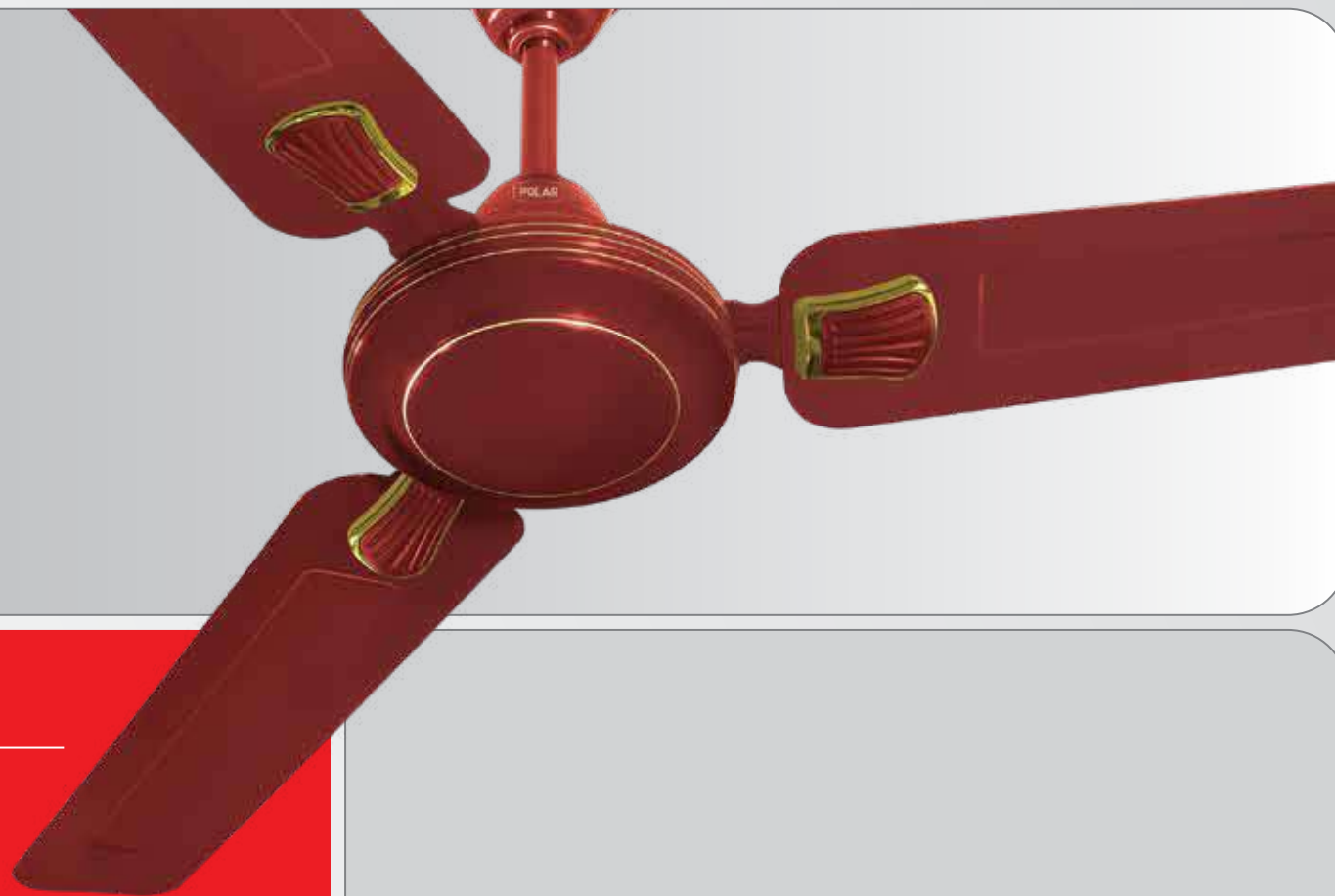

PAYTON

Energy-saving Fan





2 YEARS WARRANTY



BROWN (DECO MODEL)	BROWN (BASE MODEL)	IVORY (DECO MODEL)	IVORY (BASE MODEL)	WHITE (DECO MODEL)	WHITE (BASE MODEL)	BROWN (600 MM)
-----------------------	-----------------------	-----------------------	-----------------------	-----------------------	-----------------------	-------------------

Features

-  Powerful and energy-efficient motor
-  Aerodynamically designed ribbed blades for high air thrust

- Powder coated for longer life
- Available in base & deco models (Deco model available in 1200 mm sweep)

TECHNICAL SPECIFICATIONS

Sweep in mm	Power Input in Watts	Speed in RPM	Air Delivery in CMM	Service Value in CMM/Watts
600	70	850	105	1.5
900	40	425	132	3.3
1200	52	360	210	4.0
1400	60	310	252	4.2



BROWN (DECO MODEL)

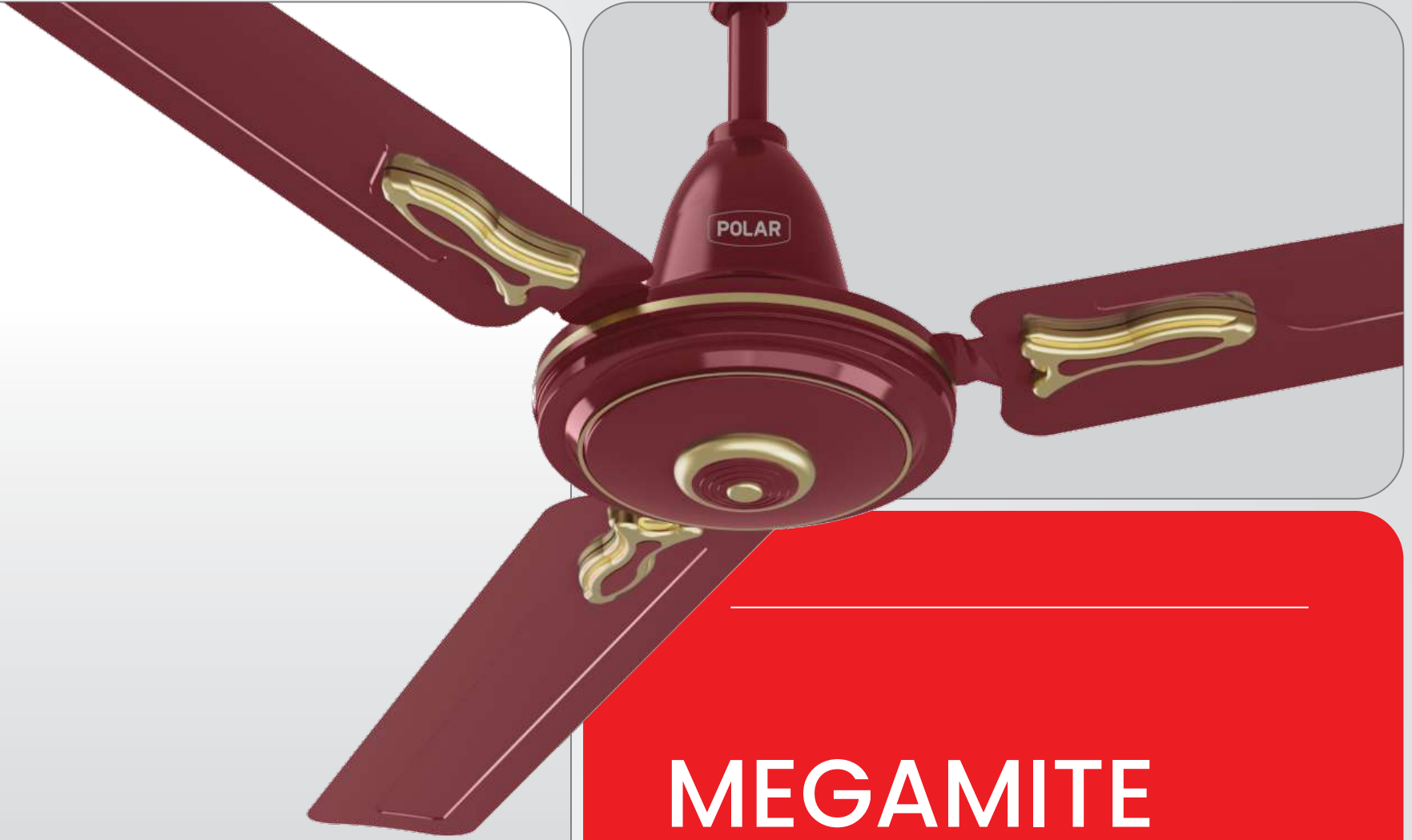

MEGAMITE

Energy-saving Fan



2 YEARS WARRANTY



BROWN
(DECO & BASE MODEL)

IVORY
(DECO & BASE MODEL)

WHITE
(DECO & BASE MODEL)



MATT BROWN
(DECO & BASE MODEL)

SMOKE BROWN
(DECO & BASE MODEL)

BROWN
(600 MM)

Features



Powerful and energy-efficient motor with 100% copper winding



Scientifically ribbed blades for high air delivery and durability

- Powder coated for longer life
- Deco model with two-part decorative blade trims for an enhanced look (available in 900 mm and 1200 mm sweep)

TECHNICAL SPECIFICATIONS

Sweep in mm	Power Input in Watts	Speed in RPM	Air Delivery in CMM	Service Value in CMM/Watts
600	70	850	105	1.5
900	40	425	132	3.3
1200	52	400	210	4.0
1400	60	310	252	4.2



IVORY

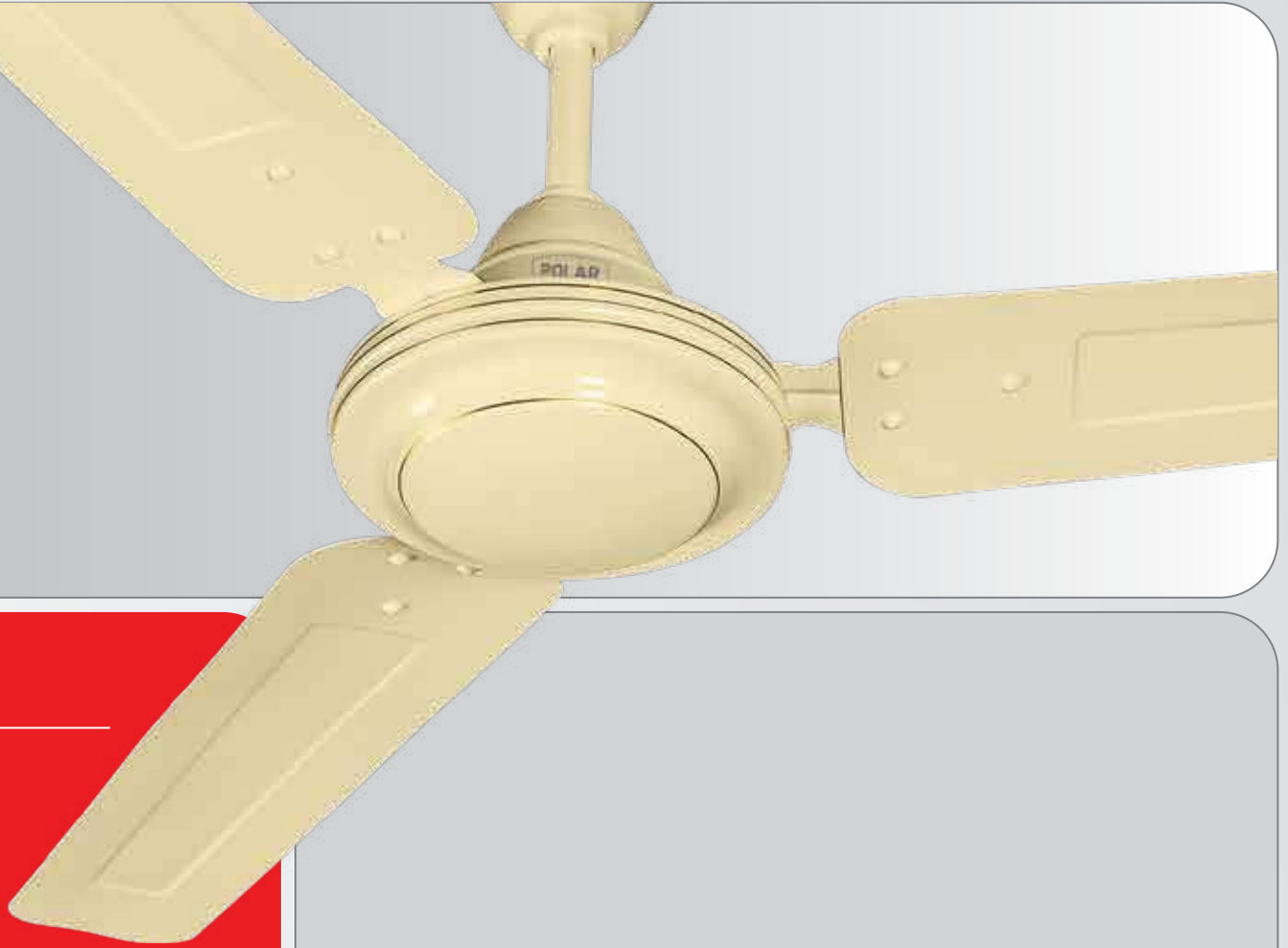

PAZERO

Energy-saving Fan



2 YEARS WARRANTY

Features



BROWN

IVORY

WHITE



Powerful and energy-efficient motor



Aerodynamically designed ribbed blades for high air thrust

- Powder coated for longer life

TECHNICAL SPECIFICATIONS

Sweep in mm
1200

Power Input in Watts
52

Speed in RPM
360

Air Delivery in CMM
210

Service Value in CMM/Watts
4.0





BROWN

WINCHESTER

Energy-saving Fan



30 MONTHS WARRANTY

Features



BROWN

IVORY

WHITE



Powerful and energy-efficient motor



Aerodynamically designed ribbed blades for high air thrust

- Powder coated for longer life
- Extended warranty period of 30 months

TECHNICAL SPECIFICATIONS

Sweep in mm

900
1200

Power Input in Watts

40
52

Speed in RPM

425
400

Air Delivery in CMM

132
210

Service Value in CMM/Watts

3.3
4.0



BROWN

WINMAX

Energy-saving Fan



30 MONTHS WARRANTY

Features



BROWN

IVORY

WHITE

 400 RPM and 1200 mm sweep for high speed

 Powerful & energy-efficient motor delivers cool air & consumes less power

 Wide aluminium blades for high air thrust

- Powder coated for premium looks

TECHNICAL SPECIFICATIONS

Sweep in mm
1200

Power Input in Watts
52

Speed in RPM
400

Air Delivery in CMM
210

Service Value in CMM/Watts
4.0



BROWN



36 SUPER SPEED

Energy-saving Fan



2 YEARS WARRANTY



BROWN

IVORY

WHITE

Features



600 RPM for super high-speed



Powerful and energy-efficient motor with 100% copper winding



30% higher air delivery than a normal 900 mm sweep fan

- Powder coated for longer life



TECHNICAL SPECIFICATIONS

Sweep in mm
900

Power Input in Watts
55

Speed in RPM
600

Air Delivery in CMM
172

Service Value in CMM/Watts
3.1

BROWN



24 SUPER SPEED

Energy-saving Fan



2 YEARS WARRANTY



BROWN

IVORY

WHITE

Features



850 RPM for super high-speed



Powerful and energy-efficient motor with 100% copper winding



Superior powder-coated paint finish for longer life

- Four-bladed fan with high air thrust
- Ideal for small spaces like Puja Rooms, Bathrooms, Kitchens, Cabins, Shops, etc.

TECHNICAL SPECIFICATIONS

Sweep in mm
600

Power Input in Watts
70

Speed in RPM
850

Air Delivery in CMM
105

Service Value in CMM/Watts
1.5





**EXCEPTIONALLY
INNOVATIVE**

TPW Fans

ANTIQUÉ BRONZE

GUSTY

Osc. Pedestal Fan



2 YEARS WARRANTY



ANTIQUÉ BRONZE

Features



Powerful and energy-efficient 100% copper motor



Autothermal overload protection device for motor



Smooth oscillation at 90°



Strong and large metal base for stability



Retro design – full metal body, spiral guard and 4-leaf aluminium blades



3-level speed control rotary switch

TECHNICAL SPECIFICATIONS

Sweep in mm
400

Power Input in Watts
55

Speed in RPM
1350

Air Delivery in CMM
80

- Telescopic arrangement for height adjustment
- Antique bronze finish

75

BLACK-SILVER



GALESTAR FARRATA

Osc. / Non-osc. Pedestal Fan



2 YEARS WARRANTY









GALESTAR FARRATA
BLACK-SILVER



GALESTAR FARRATA NEO
BLACK-SILVER

Features

-  Heavy-duty capacitor-type motor for high performance
-  Aerodynamically designed, well-balanced metal blades for excellent air delivery
-  Vibration-free operation
-  Heavy and large base for better stability
-  Telescopic arrangement for height adjustment
-  3-level speed control rotary switch

- Powder coated finish for 100% corrosion resistance and durability for longer life
- Available in oscillating and non-oscillating models

TECHNICAL SPECIFICATIONS

Sweep in mm	Power Input in Watts	Speed in RPM	Air Delivery in CMM
500	150	1400	110

BLACK-CHROME



BLUSTERY

Osc. Pedestal Fan



2 YEARS WARRANTY



BLACK-CHROME



BLACK-SILVER

Features



Aerodynamically designed aluminium blades for high air thrust and low noise



Autothermal overload protection



Smooth wide-angle oscillation



Telescopic arrangement for height adjustment

- Unique and elegant large base design for stability and enhanced aesthetic look
- Available in premium black powder coating and chrome finish guard with lacquer
- Upward and downward tilt mechanism

TECHNICAL SPECIFICATIONS

Sweep
in mm
450

Power Input
in Watts
80

Speed
in RPM
1350

Air Delivery
in CMM
100

BLACK-SILVER

FANNY

Osc. Pedestal Fan



2 YEARS WARRANTY



BLACK-SILVER

Features



Powerful and energy-efficient 100% copper motor



Autothermal overload protection



Jerk-free oscillation



Strong and large metal base for stability



Aerodynamically balanced aluminium blades for high air thrust



Childproof guard

- Upward and downward tilt mechanism
- Telescopic arrangement for height adjustment

TECHNICAL SPECIFICATIONS

Sweep in mm
400

Power Input in Watts
55

Speed in RPM
1350

Air Delivery in CMM
85

BLACK-SILVER



JETTY

Pedestal Fan



1 YEAR WARRANTY



BLACK-SILVER

Features



Powerful and high-speed 2-pole motor



High air delivery and throw

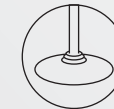

Round metal base for stability



Aluminium casted knife blades with an aerodynamic profile for high air thrust

- Telescopic arrangement for height adjustment

TECHNICAL SPECIFICATIONS

Sweep in mm
450

Power Input in Watts
140

Speed in RPM
2500

Air Delivery in CMM
80

WHITE-BLUE

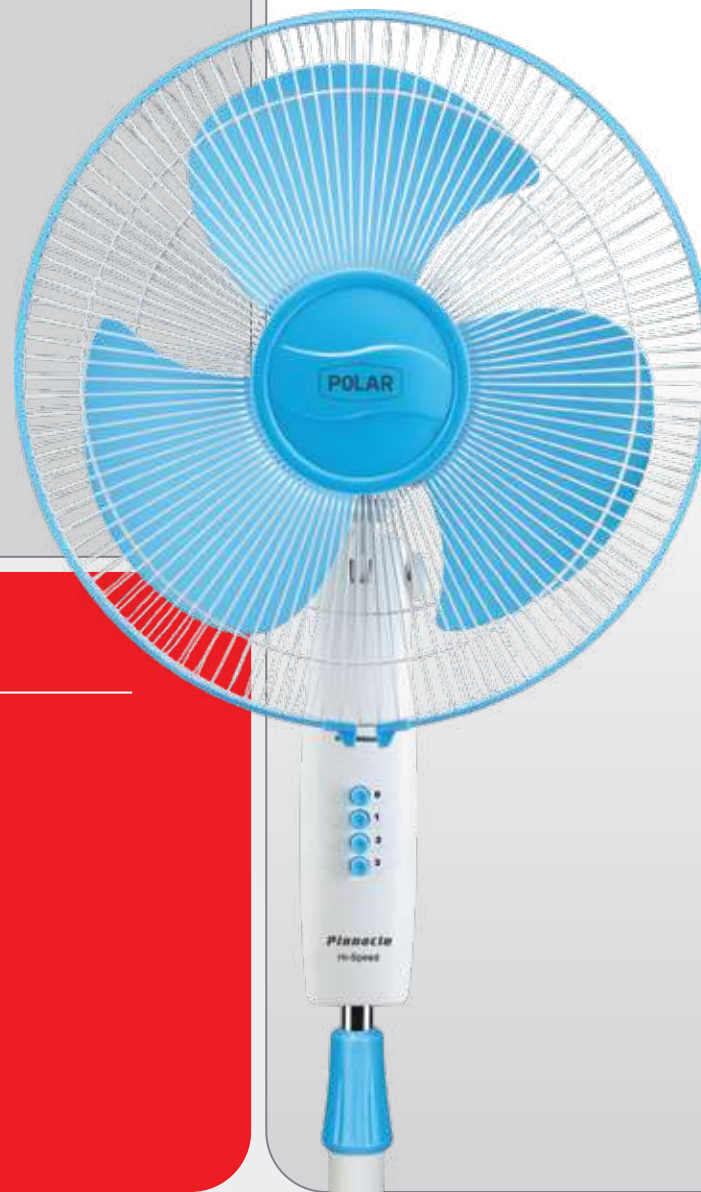

PINNACLE

Osc. Pedestal Fan



2 YEARS WARRANTY



WHITE-BLUE
(NORMAL SPEED)

BLACK-GREY
(NORMAL SPEED)

WHITE-BLUE
(HIGH-SPEED)

BLACK-GREY
(HIGH-SPEED)

Features

-  Powerful and energy-efficient 100% copper motor

-  Autothermal overload protection

-  Jerk-free oscillation

-  Strong and wide base for stability

-  Telescopic arrangement for height adjustment

-  Excellent air thrust & air delivery

-  Childproof guard

-  Silent operation

• Robust and strong built

TECHNICAL SPECIFICATIONS

Sweep in mm	Power Input in Watts	Speed in RPM	Air Delivery in CMM
Normal Speed			
400	55	1300	72
High-speed			
400	110	2200	95

YELLOW-BLACK



CONQUEST PRO

Osc. Pedestal Fan



2 YEARS WARRANTY









CHERRY RED-BLACK
(NORMAL SPEED)

YELLOW-BLACK
(NORMAL SPEED)

CHERRY RED-BLACK
(HIGH-SPEED)

YELLOW-BLACK
(HIGH-SPEED)

Features

-  Powerful and energy-efficient 100% copper motor
-  Autothermal overload protection
-  Jerk-free oscillation
-  Strong and wide base for stability
-  Telescopic arrangement for height adjustment
-  Excellent air thrust and air delivery
-  Silent operation

- Attractive colour combination for better aesthetics

TECHNICAL SPECIFICATIONS

Sweep in mm	Power Input in Watts	Speed in RPM	Air Delivery in CMM
Normal Speed			
400	55	1350	72
High-speed			
400	110	2200	95

WHITE-PURPLE

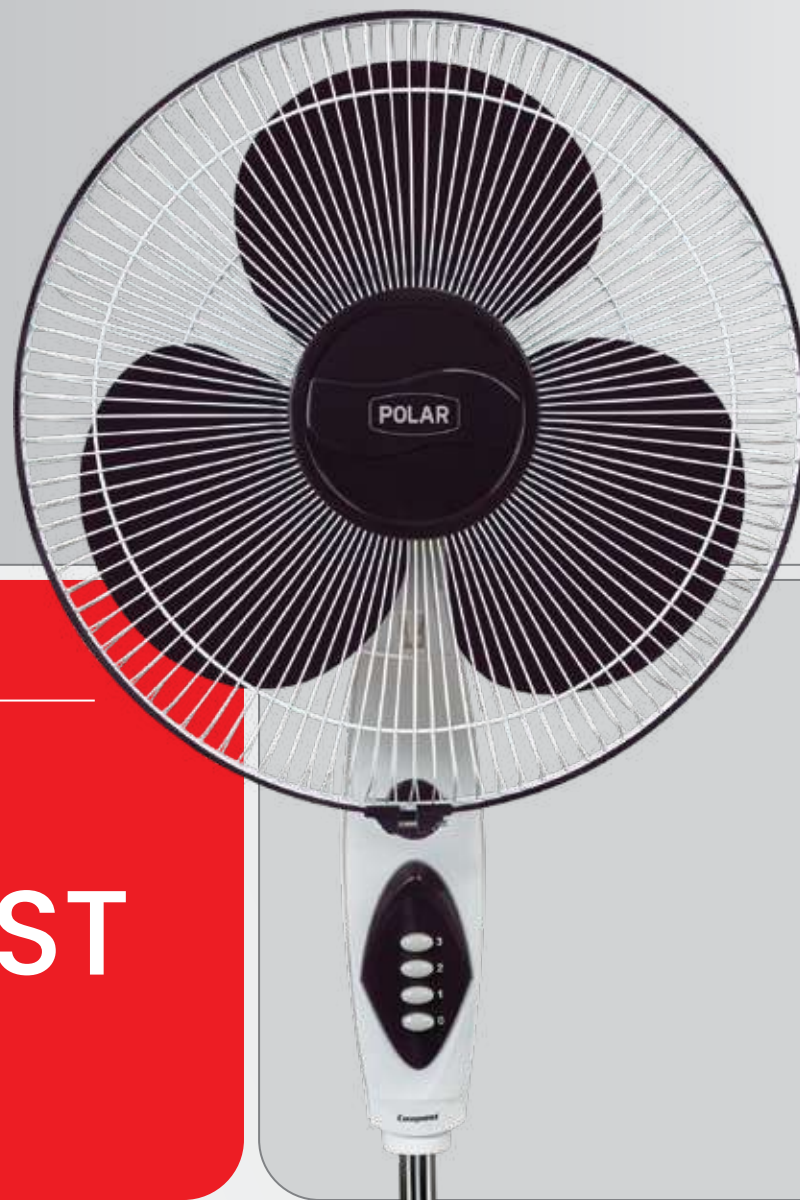

CONQUEST

Osc. Pedestal Fan



2 YEARS WARRANTY



WHITE-PURPLE
(HIGH-SPEED)



WHITE-PURPLE
(NORMAL SPEED)

Features

-  Powerful and energy-efficient 100% copper motor
-  Autothermal overload protection
-  Jerk-free oscillation
-  Strong and large base for stability
-  Excellent air thrust and air delivery
-  Silent operation

TECHNICAL SPECIFICATIONS

Sweep in mm	Power Input in Watts	Speed in RPM	Air Delivery in CMM
Normal Speed			
400	55	1350	72
High-speed			
400	110	2200	95

- Telescopic arrangement for height adjustment

WHITE-MAUVE

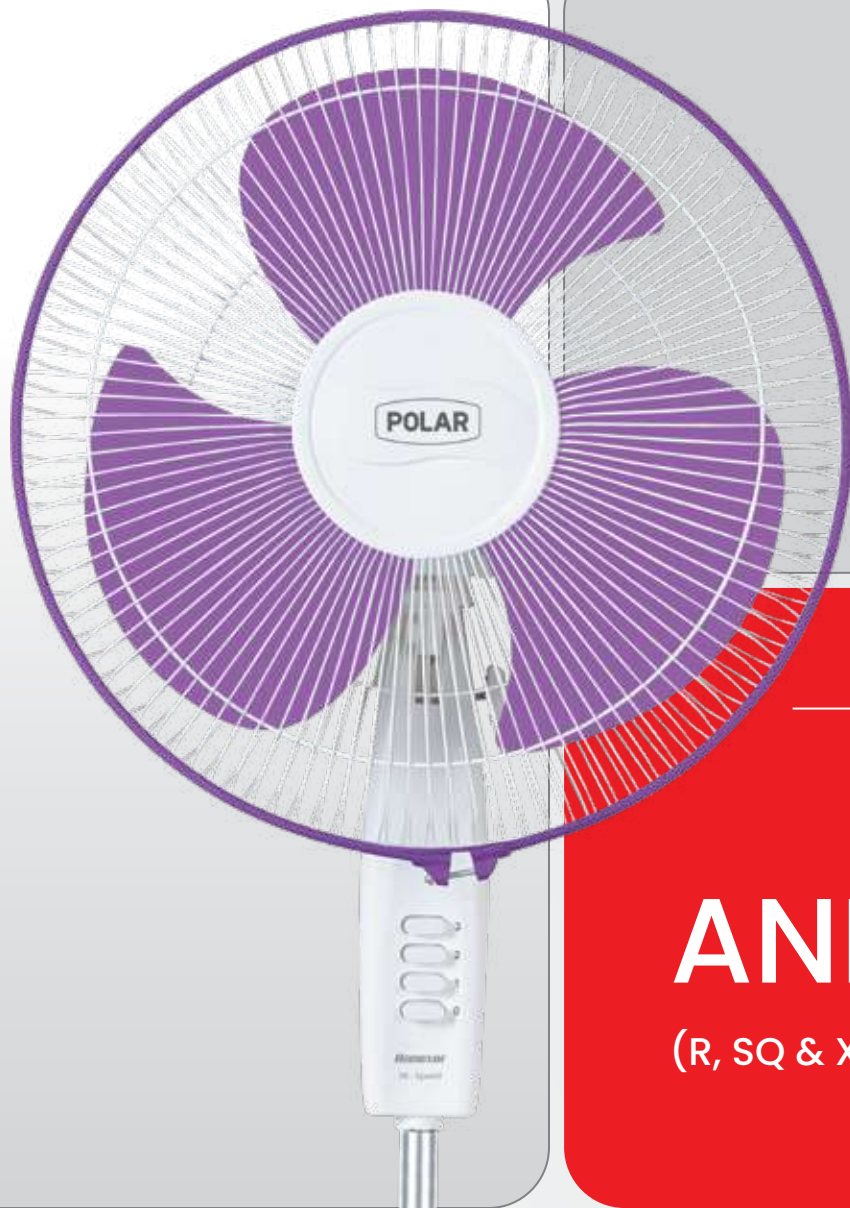

ANNEXER

(R, SQ & X Osc. Pedestal Fan)



2 YEARS WARRANTY

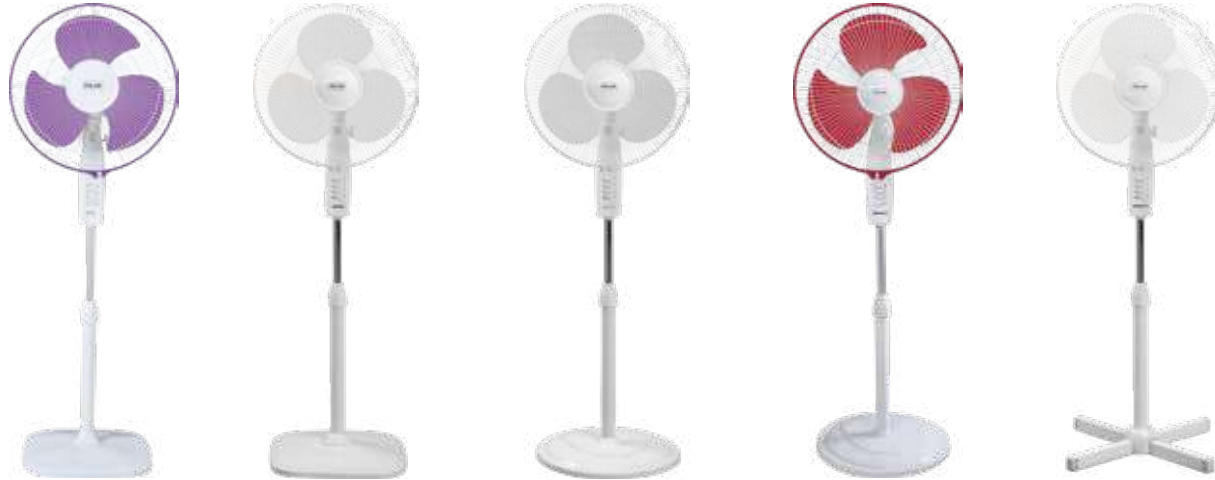

ANNEXER-SQ (HIGH-SPEED) WHITE-MAUVE	ANNEXER-SQ (NORMAL SPEED) WHITE	ANNEXER-R (NORMAL SPEED) WHITE	ANNEXER-R (HIGH-SPEED) WHITE-CHERRY RED	ANNEXER-X (NORMAL SPEED) WHITE
AVL. COLOURS	AVL. COLOURS	AVL. COLOURS	AVL. COLOURS	AVL. COLOUR
<ul style="list-style-type: none"> ● WHITE-MAUVE ● WHITE-PURPLE ○ WHITE 	<ul style="list-style-type: none"> ● WHITE-BLUE ● WHITE-CHERRY RED ○ WHITE 	<ul style="list-style-type: none"> ● WHITE-BLUE ● WHITE-CHERRY RED ○ WHITE 	<ul style="list-style-type: none"> ● WHITE-PURPLE ● WHITE-CHERRY RED ○ WHITE 	<ul style="list-style-type: none"> ○ WHITE

Features

-  Powerful and energy-efficient 100% copper motor

-  Autothermal overload protection

-  Jerk-free oscillation

-  Telescopic arrangement for height adjustment

-  Excellent air thrust and air delivery

-  Silent operation

TECHNICAL SPECIFICATIONS

Model Name	Sweep in mm	Power Input in Watts	Speed in RPM	Air Delivery in CMM
Normal Speed				
Annexer-R & SQ Annexer-X	400 400	55 55	1350 1350	72 72
High-speed				
Annexer-R & SQ	400	110	2200	95

*Annexer-R & Annexer-SQ available in regular and high-speed variants

- Strong and large base for stability (cross-base model comes with stable base bracket design)

WHITE-MAROON

ANNEXER -MB

Osc. Pedestal Fan

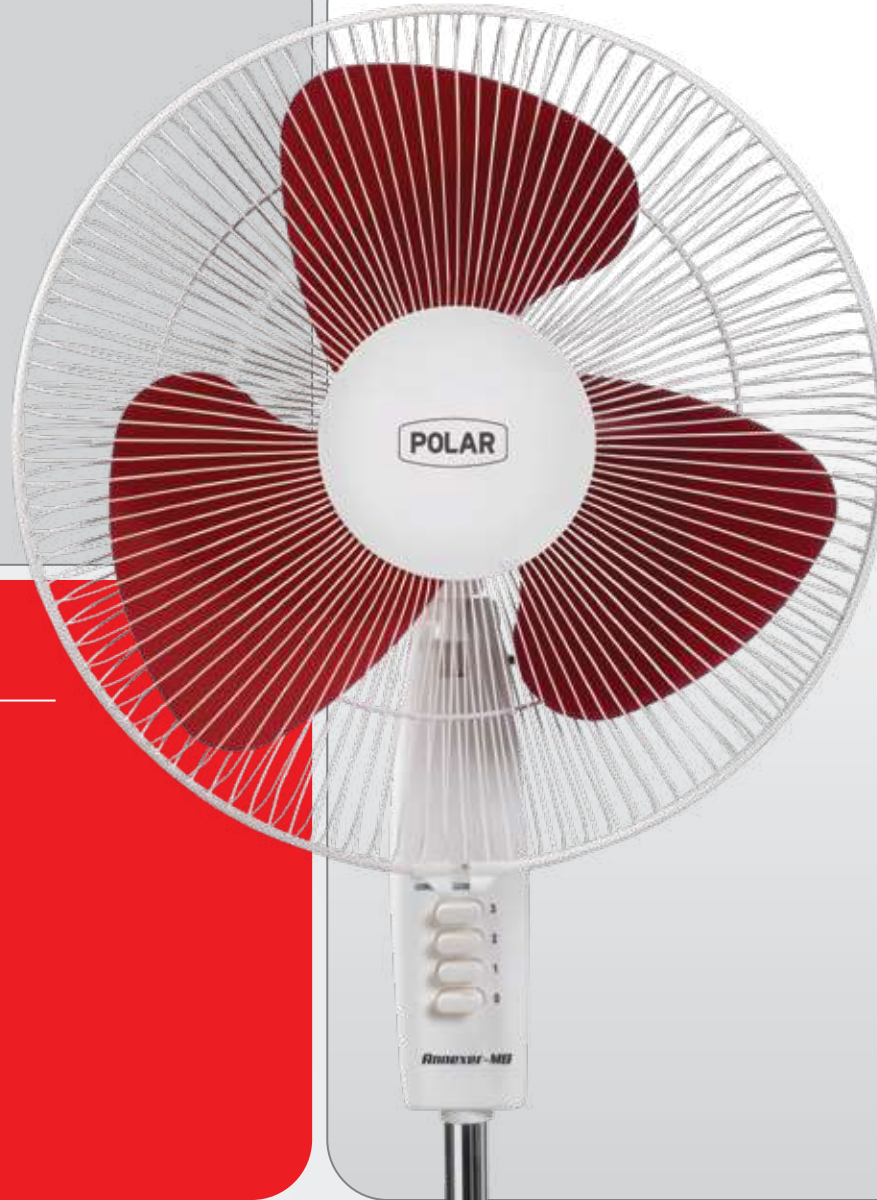

2 YEARS WARRANTY



WHITE-BLUE



WHITE



WHITE-MAROON

Features



Powerful and energy-efficient 100% copper motor



Autothermal overload protection



Jerk-free oscillation

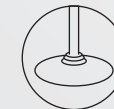

Strong and large metal base for stability



Telescopic arrangement for height adjustment



Silent operation

TECHNICAL SPECIFICATIONS

Sweep in mm
400

Power Input in Watts
55

Speed in RPM
1350

Air Delivery in CMM
75

- Sturdy and rigid aluminium blades for excellent air thrust and delivery

WHITE

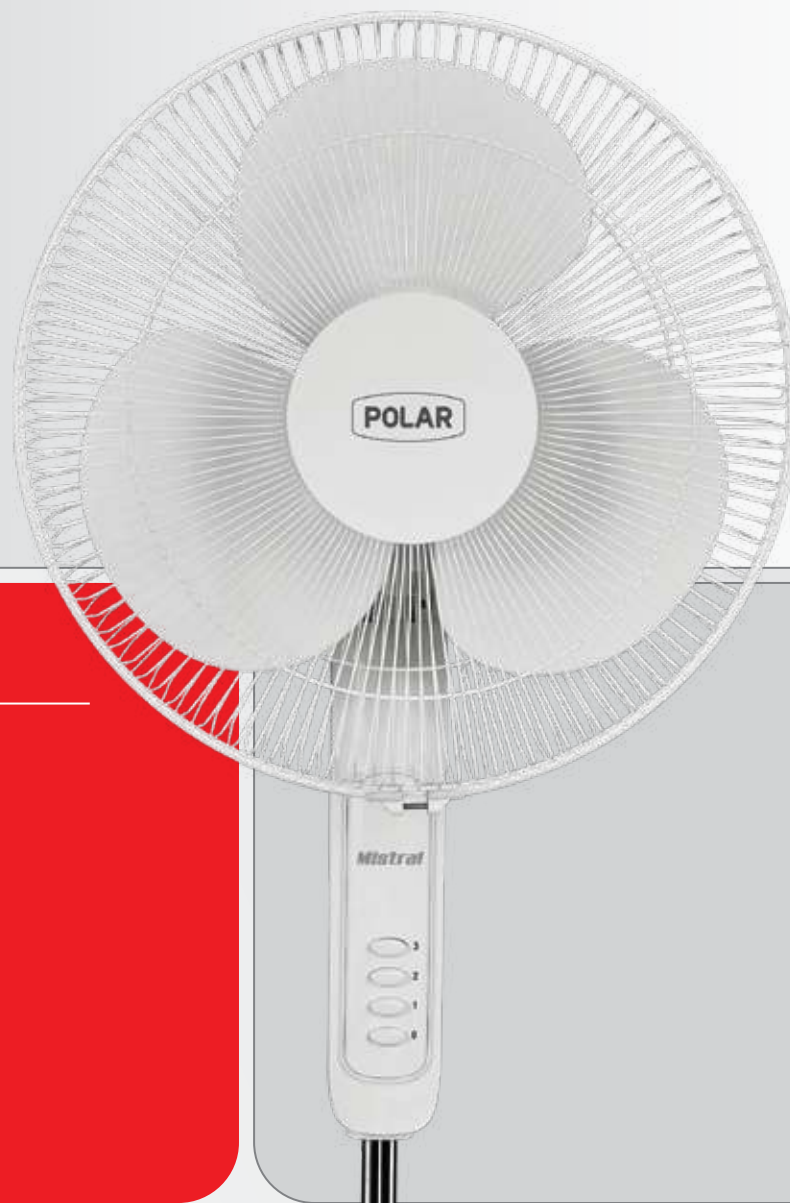

MISTRAL

Osc. Pedestal Fan









2 YEARS WARRANTY

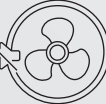

WHITE

Features

-  Powerful and energy-efficient 100% copper motor
-  Autothermal overload protection
-  Jerk-free oscillation
-  Strong & large base for better stability
-  Telescopic arrangement for height adjustment
-  Silent operation
-  Childproof guard

TECHNICAL SPECIFICATIONS

Sweep
in mm
400

Power Input
in Watts
55

Speed
in RPM
1350

Air Delivery
in CMM
72

- Excellent air thrust & air delivery

BLACK-SILVER



BLUSTERY

Osc. Wall Fan



2 YEARS WARRANTY



BLACK-SILVER

Features



Powerful
100% copper
motor



Full metal
construction



Autothermal
overload
protection



Wide-angle
oscillation



Upward and
downward tilt
mechanism

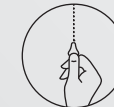

Pull cord
mechanism for
speed control



Aerodynamically
designed aluminium
blades for high air
thrust and delivery

TECHNICAL SPECIFICATIONS

Sweep
in mm
450

Power Input
in Watts
80

Speed
in RPM
1350

Air Delivery
in CMM
100

- Available in premium black powder coating and chrome finish guard with lacquer

BLACK-SILVER



FANNY

Osc. Wall Fan



2 YEARS WARRANTY



BLACK-SILVER

Features

-  Powerful and energy-efficient 100% copper motor
-  Autothermal overload protection
-  Jerk-free oscillation
-  Silent operation
-  Upward and downward tilt mechanism
-  Aerodynamically balanced aluminium blades for high air thrust
-  Pull cord mechanism for oscillation and speed control along with ON/OFF

TECHNICAL SPECIFICATIONS

Sweep
in mm
400

Power Input
in Watts
55

Speed
in RPM
1350

Air Delivery
in CMM
85

- Extra ribs on the front and back guard for enhanced safety

WHITE-BLUE

PINNACLE

Osc. Wall Fan

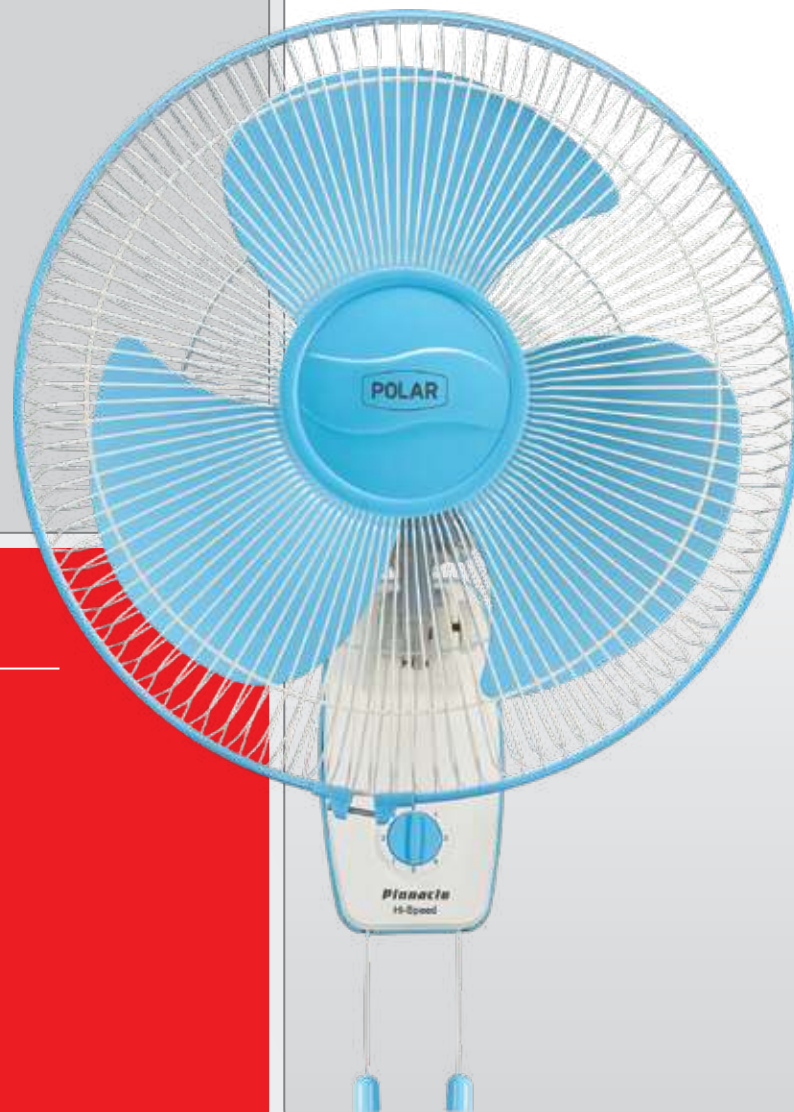

2 YEARS WARRANTY



WHITE
(NORMAL SPEED)



WHITE-MAROON
(NORMAL SPEED)



WHITE-BLUE
(NORMAL SPEED)



WHITE
(HIGH-SPEED)



WHITE-MAROON
(HIGH-SPEED)



WHITE-BLUE
(HIGH-SPEED)

Features

 Powerful and energy-efficient 100% copper motor

 Autothermal overload protection

 Jerk-free smooth oscillation

 Upward and downward tilt mechanism

 Aerodynamically balanced blades for high air delivery

 Pull cord for oscillation and speed control

 3-level speed control rotary switch

- Attractive colour combination for better aesthetics
- Sleek and stylish aesthetic look

TECHNICAL SPECIFICATIONS

Sweep in mm	Power Input in Watts	Speed in RPM	Air Delivery in CMM
Normal Speed			
400	55	1350	72
High-speed			
400	110	2200	95

YELLOW-BLACK



CONQUEST PRO

Osc. Wall Fan



2 YEARS WARRANTY



YELLOW-BLACK
(HIGH-SPEED)



CHERRY RED-BLACK
(HIGH-SPEED)



YELLOW-BLACK
(NORMAL SPEED)



CHERRY RED-BLACK
(NORMAL SPEED)

Features

-  Powerful and energy-efficient 100% copper motor
-  Autothermal overload protection
-  Jerk-free smooth oscillation
-  Silent operation
-  Excellent air thrust and air delivery
-  Pull cord for oscillation and speed control

TECHNICAL SPECIFICATIONS

Sweep in mm	Power Input in Watts	Speed in RPM	Air Delivery in CMM
Normal Speed			
400	55	1350	72
High-speed			
400	110	2200	95

- Attractive colour combination for better aesthetics

WHITE-PURPLE

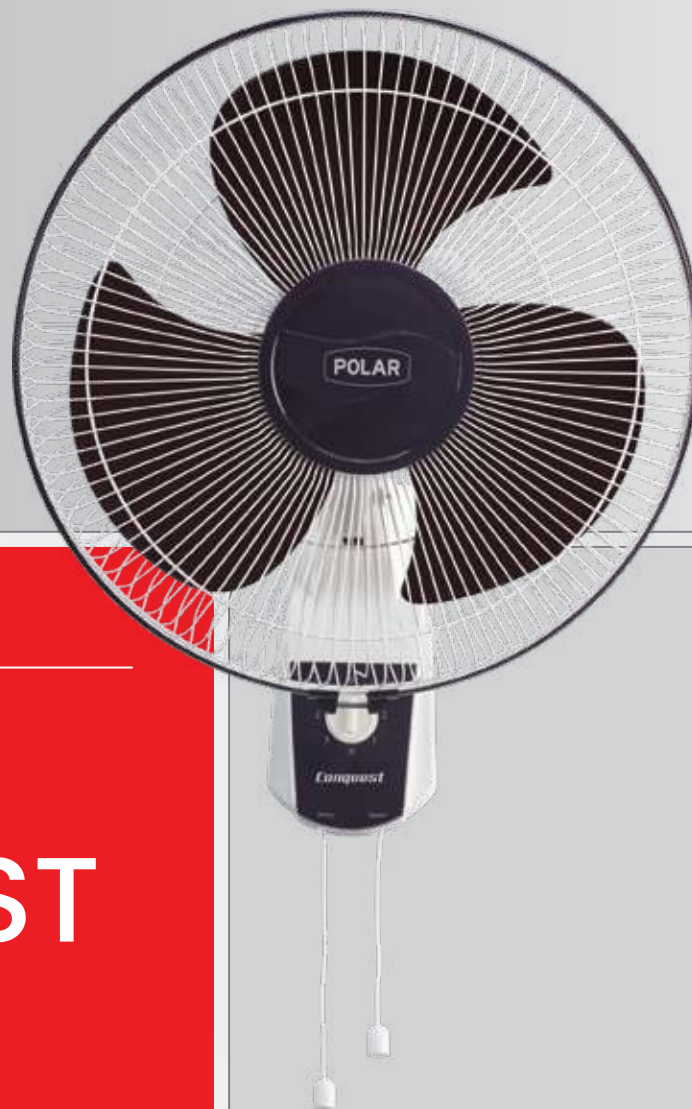

CONQUEST

Osc. Wall Fan



2 YEARS WARRANTY



WHITE-PURPLE
(NORMAL SPEED)



WHITE-PURPLE
(HIGH-SPEED)

Features

 Powerful and energy-efficient 100% copper motor

 Autothermal overload protection

 Jerk-free oscillation

 Silent operation

 Excellent air thrust and air delivery

TECHNICAL SPECIFICATIONS

Sweep in mm	Power Input in Watts	Speed in RPM	Air Delivery in CMM
Normal Speed			
400	55	1350	72
High-speed			
400	110	2200	95

- Pull cord for oscillation and speed control

105



BLACK

ANNEXER

Osc. Wall Fan



2 YEARS WARRANTY



BLACK
(HIGH-SPEED)



WHITE
(NORMAL SPEED)



WHITE
(HIGH-SPEED)

Features

-  Powerful and energy-efficient 100% copper motor
-  Autothermal overload protection
-  Jerk-free oscillation
-  Upward and downward tilt mechanism
-  Aerodynamically designed high-grade polymer blades for maximum air delivery
-  Pull cord for oscillation and speed control

TECHNICAL SPECIFICATIONS

Sweep in MM	Power Input in Watts	Speed in RPM	Air Delivery in CMM
Normal Speed			
400	55	1350	72
High-speed			
300	75	2200	70
400	110	2200	95

- Extra protection against corrosion with powder-coated guard and polymer ring
- Unique bronze bush with improved lubrication for durability

107

WHITE-BLUE

ANNEXER -MB

Osc. Wall Fan

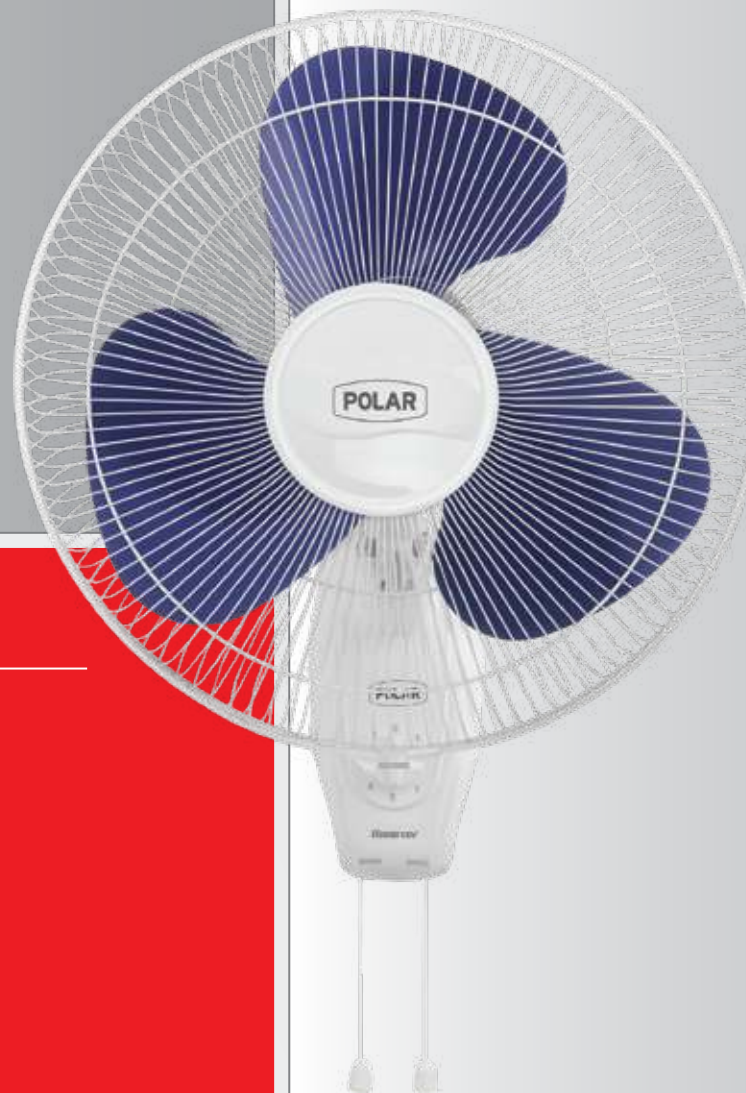

2 YEARS WARRANTY



WHITE-BLUE



WHITE



WHITE-MAROON

Features



Powerful and energy-efficient 100% copper motor



Autothermal overload protection



Jerk-free oscillation



Upward and downward tilt mechanism



Sturdy and rigid aluminium blades for high air thrust

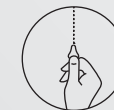

Pull cord for oscillation and speed control

- Extra protection against corrosion with powder-coated guard and polymer ring
- Unique bronze bush with improved lubrication for durability

TECHNICAL SPECIFICATIONS

Sweep in mm
400

Power Input in Watts
55

Speed in RPM
1350

Air Delivery in CMM
75

BLACK-SILVER



GALESTAR FARRATA

Osc. Wall & Cabin Fan



1 YEAR WARRANTY



BLACK-SILVER
OSC. WALL

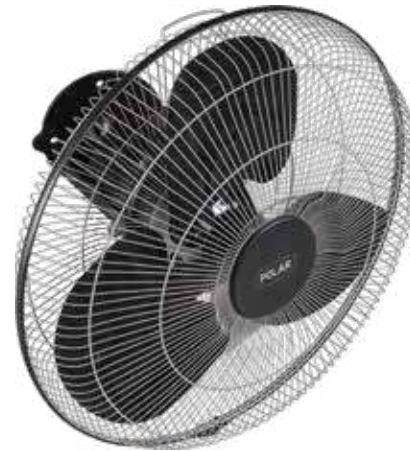

BLACK-SILVER
CABIN FAN

Features



Heavy-duty powerful motor



3-speed push-button control for oscillating model

- Aerodynamic 3 petal-shaped blades in aluminium construction for high air thrust at minimum noise
- Sturdy wire mesh guard and epoxy powder coated for corrosion resistance and extra safety
- Ideal choice for places requiring coverage of air over large areas with a constraint of floor space
- Wall mounting model available with oscillation & swivelling arrangement
- Oscillating model with a counterweight on the motor for smooth oscillation

TECHNICAL SPECIFICATIONS

Sweep
in mm

500

Power Input
in Watts

150

Speed
in RPM

1400

Air Delivery
in CMM

110

WHITE-PURPLE



CONQUEST

Osc. Table Fan



2 YEARS WARRANTY









WHITE-PURPLE
(HIGH-SPEED)

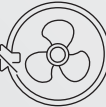

WHITE-PURPLE
(NORMAL SPEED)

Features

-  Powerful and energy-efficient 100% copper motor
-  Autothermal overload protection
-  Jerk-free oscillation
-  Strong and large base for stability
-  Silent operation
-  Excellent air thrust and air delivery

TECHNICAL SPECIFICATIONS

Sweep in MM	Power Input in Watts	Speed in RPM	Air Delivery in CMM
Normal Speed			
400	55	1350	72
High-speed			
400	110	2200	95

- 3-speed push-bottom switch control

WHITE-MAUVE

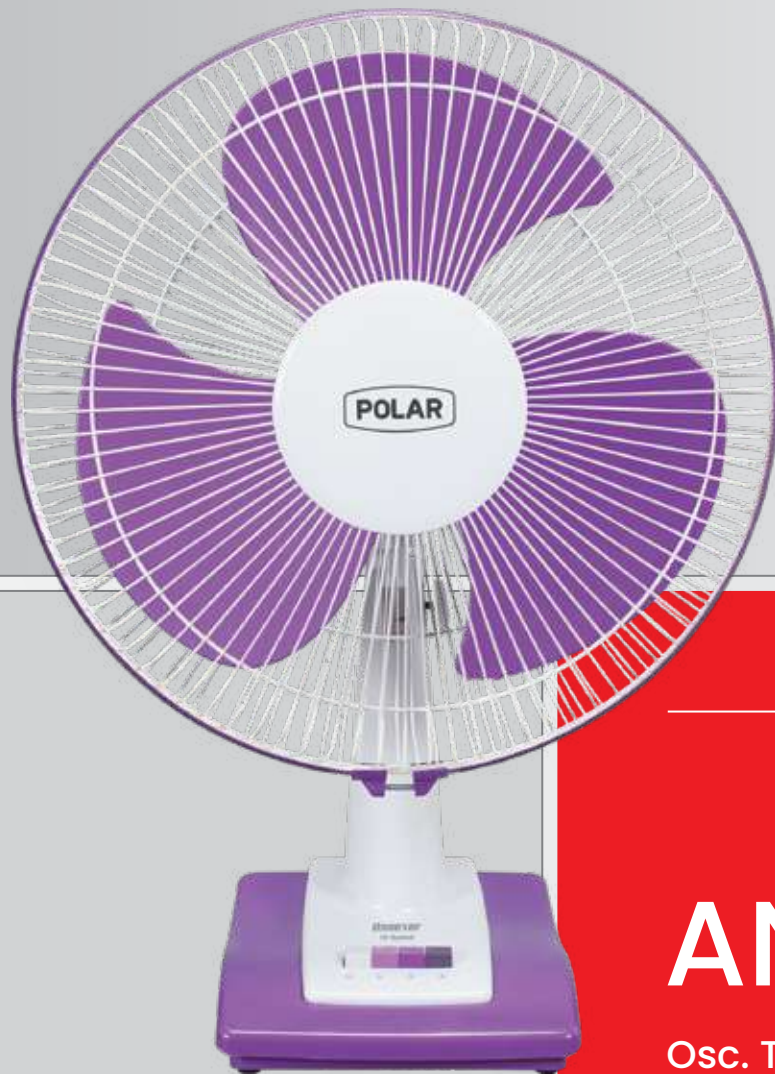

ANNEXER

Osc. Table Fan



2 YEARS WARRANTY



WHITE-BLUE
(NORMAL SPEED)



WHITE-MAUVE
(NORMAL SPEED)



WHITE-BLUE
(HIGH-SPEED)



WHITE-MAUVE
(HIGH-SPEED)

Features

-  Powerful and energy-efficient 100% copper motor
-  Autothermal overload protection
-  Smooth wide-angle oscillation
-  Strong and large base for stability
-  Silent operation
-  Upward and downward tilt mechanism
-  3-speed push-button switch control

- Extra protection against corrosion with powder-coated guard and polymer ring
- Unique bronze bush with improved lubrication for durability
- Aerodynamically designed high-grade polymer blades for maximum air delivery

TECHNICAL SPECIFICATIONS

Sweep in mm	Power Input in Watts	Speed in RPM	Air Delivery in CMM
Normal Speed			
400	55	1350	72
High-speed			
400	110	2200	95

A DYNAMIC RANGE FOR DYNAMIC NEEDS



WHITE-GREY



ANNEXER

All Purpose Fan



1 YEAR WARRANTY



WHITE-GREY
(HIGH-SPEED)

Features



Energy-efficient & powerful motor for durability



High-grade polymer blades scientifically profiled for high air thrust



Multi-use application

- Extra protection against corrosion with powder-coated guard and polymer ring

TECHNICAL SPECIFICATIONS

Sweep
in mm
300

Power Input
in Watts
80

Speed
in RPM
2300

Air Delivery
in CMM
80

BLACK-CHROME

STORMY NEO

Multi-utility Fan





1 YEAR WARRANTY



BLACK-CHROME
(HIGH-SPEED)

Features

-  Heavy-duty 100% copper motor for durability
-  2800 RPM for high air thrust
-  Novel rocker arrangement to swivel by 360° horizontally & 180° vertically

- 2-in-1 advantages of wall mounting & table/desktop usage

TECHNICAL SPECIFICATIONS

Sweep
in mm
230

Power Input
in Watts
45

Speed
in RPM
2800

Air Delivery
in CMM
26

Air Velocity
in M/Min
268

121

WHITE

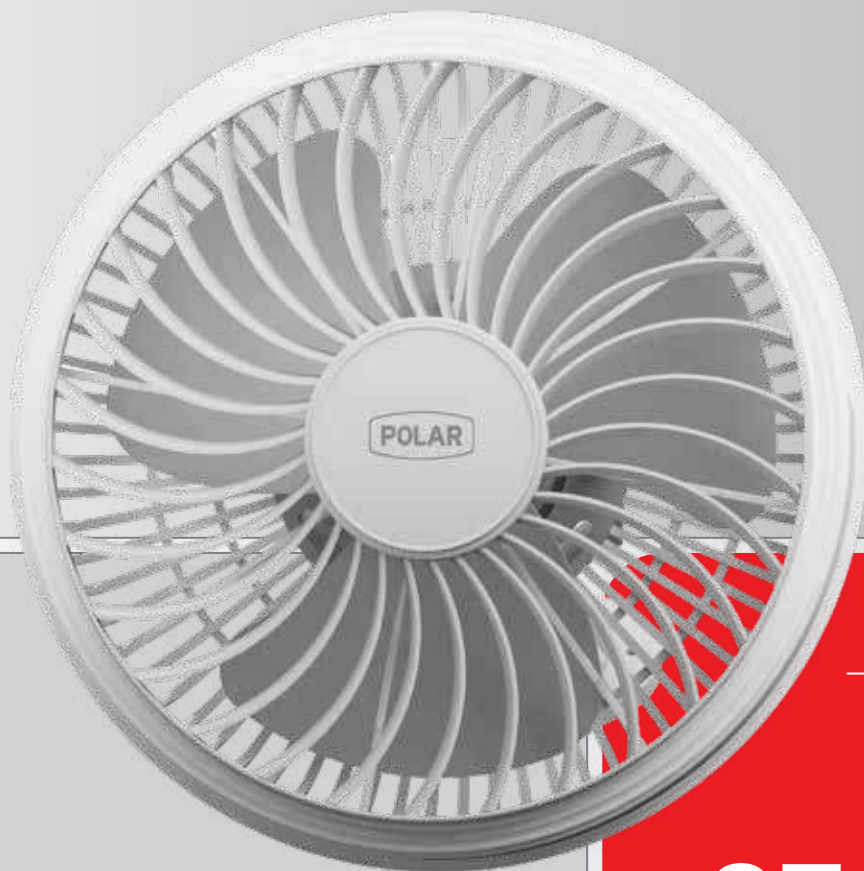

STORMY

Cabin Fan



2 YEARS WARRANTY



WHITE

Features



100% copper motor for durability



All-round air delivery with rotating grille



Powerful motor for high air delivery



High-grade polymer revolving grille



Overheat protection

TECHNICAL SPECIFICATIONS

Sweep
in mm
300

Power Input
in Watts
85

Speed
in RPM
2100

Air Delivery
in CMM
58

- Aerodynamic blades for faster speed and high air delivery



**FRESH
INDOORS
ALWAYS**

Exhaust Fans

125

CLEAN AIR DUO



CLEAN AIR

Metal Exhaust Fan



2 YEARS WARRANTY



CLEAN AIR HIGH-SPEED & HIGH-SPEED NEO



CLEAN AIR METAL EXHAUST



CLEAN AIR DUO



CLEAN AIR DELUXE



CLEAN AIR SELECT DUO



CLEAN AIR SELECT

Features

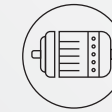

Robust motor for powerful performance and longer life



Metal/resin blades with safety Guard (optional) for longer life



Clean Air Duo & Clean Air Select Duo rotates in both clockwise & anti-clockwise directions



High-speed model with a powerful motor and high air suction



Powder-coated finish

TECHNICAL SPECIFICATIONS

Model Name	Sweep in mm	Power Input in Watts	Speed in RPM	Air Delivery in CMH
Clean Air Select	150/230/300	40/42/65	2600/1350/1300	550/750/1750
Clean Air High-speed	150/230	55/50	2600/2650	550/950
Clean Air Metal Exhaust	230/300	40/50	1350/1300	520/1250
Clean Air Duo	230	60	2650	950/900
Clean Air High-speed Neo	230	60	2600	950
Clean Air Deluxe	230/300	50/65	1300/1270	650/1250
Clean Air Select Duo	230	42	1350	750/550
Clean Air Select Duo	300	65	1300	1750/1050

- Clean Air Select model has double ball bearings and heavy-duty 4-leaf blades, and it is mounted on an aluminium carrier and powder-coated carrier in a metallic colour
- Deluxe and metal exhaust available with non-capacitor motor
- Ideal for Kitchens, Bathrooms, Restaurants and also for low-end industrial use (for selected models)

CLEAN AIR PASSION-CM (WHITE)



CLEAN AIR

Plastic Ventilating Fan



2 YEARS WARRANTY



CLEAN AIR PASSION*



CLEAN AIR PASSION NEO*



CLEAN AIR PASSION BLDC*



AXIAL FLOW (AF)*



CLEAN AIR-VH**





CLEAN AIR PASSION-CM

*AVAILABLE COLOURS: ○ WHITE | ● IVORY | ● BLACK

**AVAILABLE COLOURS: ○ WHITE | ● IVORY | ● WOOD FINISH

Features

-  Robust motor for powerful performance and longer life
-  High-grade thermoplastic polymer body and blades
-  Powerful air suction for fresh & odourless air
-  Lightweight rust-proof body

- Self-open and close shutter to prevent dust and foreign materials (on select models only)
- Easy screw-less installation, can be mounted on glass/window panel
- Convenient removal of front shutter for easy cleaning (VH)
- Powerful robust motor & suitable for Armstrong false ceiling installation (Clean Air Passion - CM)
- Powerful & energy-efficient BLDC motor for low electricity consumption

TECHNICAL SPECIFICATIONS

Model Name	Sweep in mm	Power Input in Watts	Speed in RPM	Air Delivery in CMH	
Clean Air Passion-Axial Flow	100/150/200	18/22/25	2500/1800/2000	90/250/350	
Clean Air Passion-VH	100/150	18/22	2500/1800	85/220	
Clean Air Passion Neo	150/200/250	33/36/40	1350/1300/1250	300/500/750	
Clean Air Passion BLDC	150/200/250	6/12/14	1350/1350/1350	250/500/750	
Normal Speed					
Clean Air Passion	150/200/250	35/38/40	1350/1300/1250	300/500/750	
High-Speed					
Clean Air Passion	150/200	40/65	2500/2100	500/750	
Model Name	Blower Dia in mm	Frame Size in mm	Power Input in Watts	Speed in RPM	Air Delivery in CMH
Clean Air Passion-CM	130	250	35	1350	200

**COMFORT
IN EVERY
CORNER**



BLACK-SILVER



GALESTAR

Air Circulator Fan



1 YEAR WARRANTY



BLACK-SILVER



BLACK-SILVER

Features



Heavy-duty and powerful 100% copper motor



Heavy and robust base for better stability



Powder-coated paint with a metallic finish protects the fan from corrosion



Aerodynamically designed aluminium blades for high air delivery

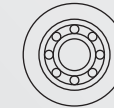

Double ball bearings for longer life

- Heavy-duty and powerful motor for optimum performance even at low voltage
- Precision-built oscillating mechanism with an indexing option and 90° oscillation
- Performance generally conforms to IS-2997-1964 with up-to-date amendments

TECHNICAL SPECIFICATIONS

Sweep in mm	Power Input in Watts	Speed in RPM	Air Delivery in CMM	Min. Peak Air Velocity in M/Min
450	100	1400	150	250
600	180	1400	280	250
750	250	1400	370	245

WINDPOWER



CLEAN AIR

Heavy-duty Metal Ventilating Fan





2 YEARS WARRANTY



WINDPOWER

Features

-  Powerful and efficient 100% copper motor with double ball bearings
-  Autothermal overload protection (optional)
-  ISI approved
-  Anti-corrosive powder coated glossy finish

- Designed to effectively combat pollution and remove smoke, dust and other pollutants, keeping the workplace clean and fresh
- Conforms to IS 2312-1967
- Available in IP-55 degree of enclosure for protection against dust and water ingress (optional)
- Dynamically balanced heavy-duty impeller
- Available to suit single-phase and 3-phase supply

TECHNICAL SPECIFICATIONS

Sweep in mm	Power Input in Watts	Speed in RPM	Air Delivery in CMH (under free airflow condition)
300	82	1400	1900
300	50	900	1270
380	150	1400	3600
380	90	900	2220
450	370	1400	6800
450	132	900	4340
600	500	900	10450



COOLER KIT



1 YEAR WARRANTY



COOLER FAN



MINI SUBMERSIBLE PUMP

Features



Powerful and energy-efficient capacitor-type motor



Bronze bush with adequate lubrication for enhanced life

TECHNICAL SPECIFICATIONS

Cooler Motor				
Sweep in mm	Power Input in Watts	Speed in RPM	H. P.	Max. AMP.
300	105	2700	1/10	0.5
400	150	1400	1/7	0.7
450	350	1400	1/4	1.7
Mini Submersible Pump				
Type	Power Consumption in Watts	Maximum Head	Maximum Flow	Max. Cooler Height Recommended
Regular	18	1.8 mtrs.	800 LPH	1.2 mtrs.
Jumbo	38	2.8 mtrs.	1200 LPH	1.8 mtrs.
Cooler Fan				
Sweep in mm	Power Input in Watts	Speed in RPM	Air Delivery in CMH	
500	150	1400	6000	

- Broad leaf in aluminium sheet, scientifically designed and mounted on MS carrier to make sturdy construction and produce high air delivery
- Essential gadget for room/desert coolers used in domestic/commercial establishments for maximum cooling
- Mini submersible pump in a normal and jumbo model takes care of high water flow with a higher delivery head

INSTALLATION DIAGRAM

CLEAN AIR PASSION

Dimensional Guidelines for Installation

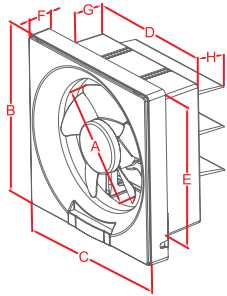

A (Sweep)	B	C	D	E	F	G	H
150	243	243	175	175	32	84	70
200	293	293	242	242	42	89	58
250	345	345	292	292	42	89	71

Installation Instruction

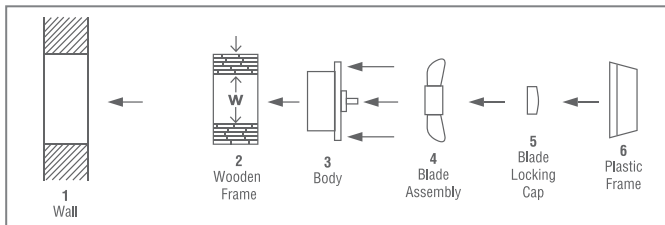

Connection Diagram

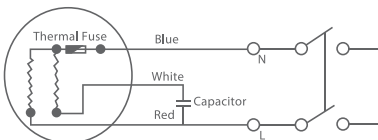

Wooden Frame Cutout Sizes

- 177 × 177 (for 150 mm)
- 245 × 245 (for 200 mm)
- 295 × 295 (for 250 mm)

AXIAL FLOW

Cutout Size Guidelines

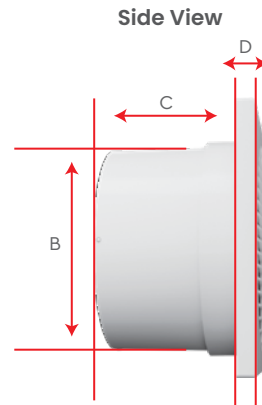

Front View

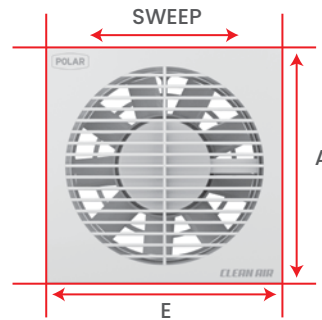

Clean Air Axial Flow Ventilating Fan - Detailed Chart

All sizes are in mm					
Sweep	A	B	C	D	E
100	152	110	90	12	152
150	180	148	90	12	180
200	222	185	108	12	222

CLEAN AIR PASSION-VH

Installation & Maintenance Instructions

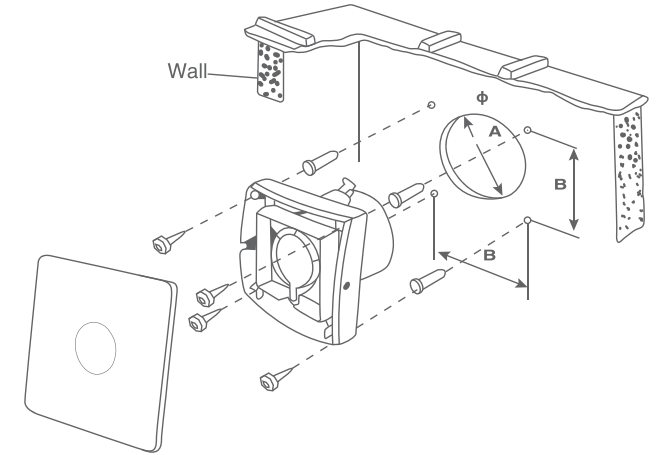

Type	A	B
100 mm	110	115
150 mm	150	146
200 mm	185	180

Wiring Instruction & Diagram

Connect Black & Red Wires to Supply
230 V, AC, 50 Hz, 1-Ph

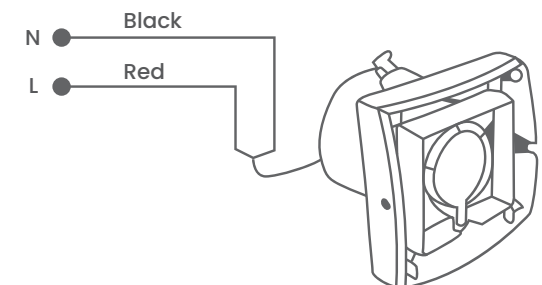

CLEAN AIR PASSION-CM

Dimensions

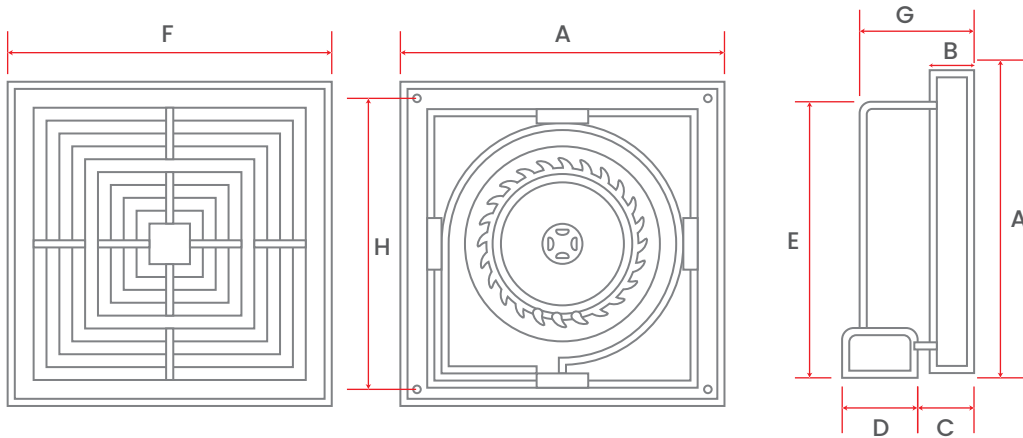

Wiring Diagram

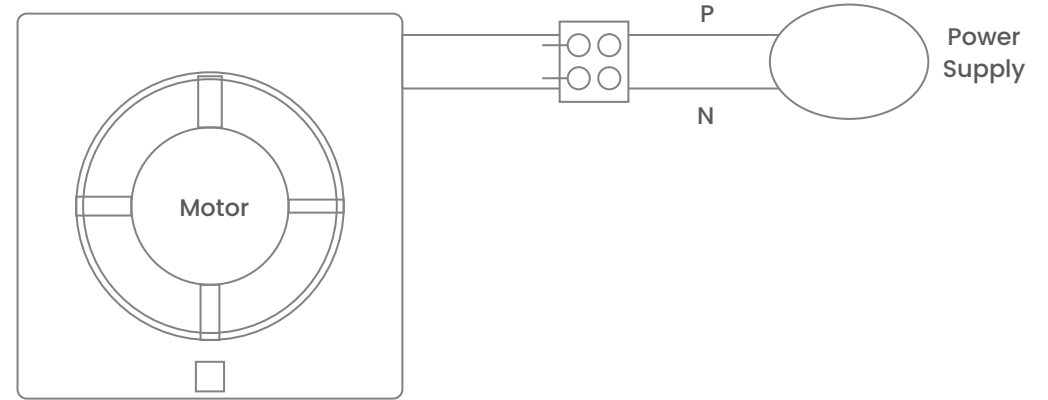

Note: All Dimensions are in mm

Installation Dimensions

*Fixing Hole Distance

Blower Dia	A (mm)	B (mm)	C (mm)	D (mm)	E (mm)	F (mm)	G (mm)	H (mm)*
130 mm	250	40	50	98	193	252	130	228

General Guidelines for Selection of Ceiling Fans & Domestic Exhaust Fans

Model Size	Sweep	Suitable for Room Size
Ceiling Fan	600 mm	For small Shops, Cabins & Toilets
Ceiling Fan	900 mm	2.1 x 3 mtrs.
Ceiling Fan	1050 mm	3 x 3 mtrs.
Ceiling Fan	1200 mm	3.7 x 4 mtrs.
Ceiling Fan	1400 mm	4.3 x 5 mtrs.
Domestic Exhaust Fan	150/200 mm	2 x 2 x 2.8 mtrs.
Domestic Exhaust Fan	230 mm	2.4 x 2.4 x 2.8 mtrs.
Domestic Exhaust Fan	300 mm	3 x 2.4 x 2.8 mtrs.

For Large Halls, Auditoriums and Offices, Install Two or More Ceiling Fans with a Spacing Specified Below

Sweep of Fan	Centre Distance
900 mm	2 mtrs.
1050 mm	2.1 mtrs.
1200 mm	2.4 mtrs.
1400 mm	3 mtrs.

POLAR

Makes life easy

VISHVA ELECTROTECH LTD.

CIN: U31501WB2009PLC132426

(Licensed user of POLAR Trade Mark)

Regd. Off.: Unit No. 8B & 8C, 8th Floor

23 Circus Avenue, Kolkata 700 017

West Bengal, India

P: (033) 6629 1829

customercare@polarelectric.in

info@polarelectric.in

polarelectric.in

f PolarIndia

MR. SOLUTIONS
CAN FIX IT!



Customer Care
033 6100 6100

BRANCHES

SOUTH

Chennai +91 89398 96009, bmmnds@polarelectric.in | Madurai +91 72990 33418, bmmad@polarelectric.in

Kochi +91 62922 59196, bmcoc@polarelectric.in | Bengaluru +91 91471 05489, bmbng@polarelectric.in

Vijayawada +91 76050 83472, bmvij@polarelectric.in | Hyderabad 90739 55030, bmhyd@polarelectric.in

EAST

Kolkata +91 62922 59198, bmkol@polarelectric.in | Bhubaneswar +91 90739 54614, bmbbs@polarelectric.in

Guwahati +91 90739 54651, bmguw@polarelectric.in | Patna +91 62923 11682, bmqptn@polarelectric.in

Ranchi +91 62923 05911, bmranchi@polarelectric.in

NORTH

Delhi +91 90739 54778, bmdel@polarelectric.in | Chandigarh (0172) 507 7258/90739 54765,

bmchd@polarelectric.in

Jaipur (0141) 403 6715/90510 56567, bmjpr@polarelectric.in | Kanpur +91 90739 54616, bmknp@polarelectric.in

Ghaziabad +91 90739 54752, bmgzb@polarelectric.in | Dehradun +91 62922 65331, bmqddn@polarelectric.in

Varanasi +91 62922 97887, bmvns@polarelectric.in

WEST & CENTRAL

Mumbai (02522) 661 973/90739 55042, bmmum@polarelectric.in

Ahmedabad +91 76040 35557, bmahm@polarelectric.in | Indore +91 91471 32821, bmind@polarelectric.in

Raipur +91 90739 54648, bmrpr@polarelectric.in

MANDATORIES: All ceiling fans are powered by double ball bearings. All ceiling fans are normally without regulators. Regulators are available separately. The technical performance figures are rated values, based on a voltage range of 220–240 V (230 V rated), 50 Hz, single phase, AC Supply. These are subject to manufacturing tolerances. Due to constant product upgradation, the models shown in the catalogue may undergo changes in features, performance or looks without prior notice. Model colours shown in the catalogue are indicative and may vary from the actual product colours. Also available is a capacitor-controlled stepped regulator on special requirement for speed control of all energy-saving ceiling fans to give power saving on regulated speed as well as to have zero-hum/noiseless operation.