

THE SOLUTION BOOK

TO LEAD AN EASY LIFE



Makes life easy





Makes life easy

ABOUT POLAR

Every lifestyle is unique and every home tells a different story. In today's fast-paced world, it has become increasingly difficult to keep up with the plethora of tasks for everyday living. This is where Polar has made a difference and continues to do so, with its ingenious range of home appliances and heaters. A company with national repute, Polar has maintained its leading position over the decades, with efficient technological solutions for Indian households. Polar is committed to simplifying daily chores with its extensive range of home appliances and heaters. Its vast range of products, including water heaters, room heaters, immersion rods, irons, mixer grinders and kitchen appliances, have been designed to cater to the ever-evolving needs of a modern family.

MAKE EVERY DAY
EFFORTLESS

Not a fan
of cold
showers?

Find the
solution
on pages

01-14

Juicy and
tasty meal
preparation
a hassle?

Easy solution
is on pages

15-26

Craving a
hot cup of
tea?

The answer
is on pages

27-30

Want to
cook
efficiently?

The key is on
pages

31-34

Outfit too
wrinkly?

For a quick fix
look at pages

35-40

Sudden
hunger
pangs?

Quick answer
is on pages

41-42

Room
too chilly?

Find the answer
on pages

43-50

Need to
multitask?

Find out how
on pages

51-54

A COSY
BATHING
EXPERIENCE



POLAR

Marbella

POLAR

Lava+

WATER
HEATER



MARBELLA | Storage Water Heater (Available in 10, 15 & 25 litres)



Glass Lined
Metal Tank



8 Bar
Pressure



Pentashield
Safety



High-density
PUF Insulation



Temperature
Control Knob



Whirlflow
Technology



Long-lasting
Metal Body



Anti-corrosion
Magnesium
Rod



Rated Power
2000 W



ISI
Approved

- Titanium enamel & blue sapphire coated Glass Lined Metal Tank for corrosion-free, long-lasting performance
- Designed for 8 bar pressure — suitable for high-rise buildings
- Magnesium anode rod with O-PRO technology enhances the life of the tank & heating element
- High-density PUF insulation keeps the water hot for a long time
- Whirlflow technology heats water quickly
- Pentashield safety (Capillary Thermal Cut-out/Multi-function Valve/Capillary Thermostat/Dry Heat Protection/Magnesium Anode Rod)
- High efficiency heating element
- **7 years warranty on the inner tank & 2 years warranty on the product

7 YEARS**
WARRANTY





GUSH | Storage Water Heater (Available in 6, 10, 15 & 25 litres)



Glass Lined
Metal Tank



8 Bar
Pressure



Pentashield
Safety



High-density
PUF Insulation



Temperature
Control Knob



Whirlflow
Technology



Anti-corrosion
Magnesium
Rod



Rated Power
2000 W



ISI
Approved

- Titanium enamel & blue sapphire coated Glass Lined Metal Tank for corrosion-free, long-lasting performance
- Designed for 8 bar pressure — suitable for high-rise buildings
- Magnesium anode rod with O-PRO technology enhances the life of the tank & heating element
- Whirlflow technology heats water quickly
- High-density PUF insulation keeps the water hot for a long time
- Pentashield safety (Capillary Thermal Cut-out/Multi-function Valve/Capillary Thermostat/Dry Heat Protection/Magnesium Anode Rod)
- High efficiency heating element
- **7 years warranty on the inner tank & 2 years warranty on the product

7 YEARS**
WARRANTY



4-star Rated





LAVA+ | Storage Water Heater (Available in 10, 15 & 25 litres)



Long-lasting
Metal Body



8 Bar
Pressure



Pentashield
Safety



High-density
PUF Insulation



Temperature
Control Knob



Whirlflow
Technology



Anti-corrosion
Magnesium
Rod



Corrosion
Proof Metal
Tank



Rated Power
2000 W



ISI
Approved

- Designed for 8 bar pressure – suitable for high-rise buildings
- Long-lasting powder coated metal body
- Whirlflow technology heats water quickly
- High-density PUF insulation keeps the water hot for a long time
- Magnesium anode rod with O-PRO technology enhances the life of the tank & heating element
- Pentashield safety (Capillary Thermal Cut-out/Multi-function Valve/Capillary Thermostat/Dry Heat Protection/Magnesium Anode Rod)
- High efficiency heating element
- **5 years warranty on the inner tank & 2 years warranty on the product











5 YEARS**
WARRANTY



Freshet



FRESHET | **Storage Water Heater**
(Available in 6, 10, 15 & 25 litres)

 Glass Lined Metal Tank	 8 Bar Pressure	 Pentashield Safety	 High-density PUF Insulation	 Temperature Control Knob
 Analogue Temperature Display	 Shock & Corrosion Proof ABS Body	 Anti-corrosion Magnesium Rod	 Rated Power 2000 W	 ISI Approved

- Titanium enamel & blue sapphire coated Glass Lined Metal Tank for corrosion-free, long-lasting performance
- Designed for 8 bar pressure — suitable for high-rise buildings
- Magnesium anode rod with O-PRO technology enhances the life of the tank & heating element
- Whirlflow technology heats water quickly
- High-density PUF insulation keeps the water hot for a long time
- Pentashield safety (Capillary Thermal Cut-out/Multi-function Valve/Capillary Thermostat/Dry Heat Protection/Magnesium Anode Rod)
- High efficiency heating element
- **7 years warranty on the inner tank & 2 years warranty on the product

7 YEARS**
WARRANTY





LEGACY+

Storage Water Heater
(Available in 6, 10, 15 & 25 litres)



Glass Lined
Metal Tank



8 Bar
Pressure



Pentashield
Safety



High-density
PUF Insulation



High Efficiency
Heating Element



Whirlflow
Technology



Shock &
Corrosion Proof
ABS Body



Anti-corrosion
Magnesium
Rod



Rated Power
2000 W



ISI
Approved

- Titanium enamel & blue sapphire coated Glass Lined Metal Tank for corrosion-free, long-lasting performance
- Designed for 8 bar pressure – suitable for high-rise buildings
- Magnesium anode rod with O-PRO technology enhances the life of the tank & heating element
- Whirlflow technology heats water quickly
- High-density PUF insulation keeps the water hot for a long time
- Pentashield safety (Thermal Cut-out/Multi-function Valve/Thermostat/Dry Heat Protection/Magnesium Anode Rod)
- 15 & 25 litres are available in horizontal and vertical variants
- **7 years warranty on the inner tank & 2 years warranty on the product

7 YEARS**
WARRANTY





LAVA | Storage Water Heater (Available in 10, 15 & 25 litres)



Long-lasting
Powder Coated
Metal Body



8 Bar
Pressure



Pentashield
Safety



High-density
PUF Insulation



High Efficiency
Heating Element



Whirlflow
Technology



Corrosion
Proof Metal
Tank



Rated Power
2000 W



ISI
Approved

- Designed for 8 bar pressure – suitable for high-rise buildings
- Magnesium anode rod with O-PRO technology enhances the life of the tank & heating element
- High-density PUF insulation keeps the water hot for a long time
- Whirlflow technology heats water quickly
- Pentashield safety (Thermal Cut-out/Multi-function Valve/Thermostat/Dry Heat Protection/Magnesium Anode Rod)
- *5 years warranty on the inner tank & 2 years warranty on the product

5 YEARS*
WARRANTY





AQUAHOT | Storage Water Heater (Available in 6, 10, 15, 25, 35 & 50 litres)



Heavy Gauge
Stainless Steel
Tank



6 Bar
Pressure



High-density
PUF Insulation



Long-lasting
Metal Body



Magnesium
Anode Rod



Rated Power
2000 W



ISI
Approved

- Heavy gauge stainless steel (SS304L) tank for longer life
- Designed for 6 bar pressure
- High-density insulation keeps the water hot for a long time
- Metal body with corrosion resistant paint
- Unique safety features – pressure release valve and anti-siphon hole
- High efficiency heating element
- 3-star rated as per BEE standards (*2-star rated for 35 & 50 litres)
- **5 years warranty on the inner tank & 2 years warranty on the product

5 YEARS**
WARRANTY



3-star Rated



5 L

REFRESHA PRO | Instant Water Heater (Available in 3 & 5 litres)



Ultra Thick
Stainless Steel
Tank



Pentashield
Safety



Neon
Indicator



Shock-proof
& Corrosion
Resistant Body



Pressure
Release Valve



Rated Power
3000/4500 W



ISI
Approved

- Ultra thick superior 304 grade SS tank with 1.0 mm (5 L) thickness for durability
- Pressure release valve & anti-siphon hole
- ISI approved heating element & thermostat
- High efficiency 3000/4500 W heating element
- *5 years warranty on the inner tank & 2 years warranty on the product



3 L

5 YEARS* WARRANTY

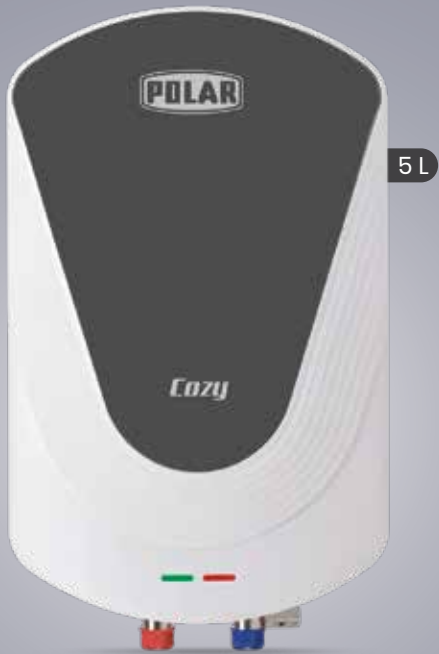

COZY | Instant Water Heater (Available in 3 & 5 litres)



Ultra Thick
Stainless Steel
Tank



Pentashield
Safety



Neon
Indicator



Shock-proof
& Corrosion
Resistant Body



Pressure
Release Valve



Rated Power
3000 W



ISI
Approved



- Ultra thick superior 304 grade SS tank with 1.0 mm (5 L) thickness for durability
- ISI approved element & thermostat
- Pressure release valve & anti-siphon hole
- High efficiency 3000 W heating element
- *5 years warranty on the inner tank & 2 years warranty on the product

5 YEARS* WARRANTY



INSTAHOT — 6L | Gas Water Heater



4X
Protection



Automatic
Ignition



20 Minutes
Inbuilt Timer



Capacity
up to 6 L



Low Pressure
Application



ISI
Approved

- 4x protection (Flame Failure Protection/Dry Burn Protection/Overheat Protection/Dry Heat Protection)
- Low pressure application — 3PSI



2 YEARS
WARRANTY



IMMERSION
WATER HEATER

IMMERSION

Electric Immersion Water Heater



Heavy-duty
Copper Tube



Rated Power
1000/1500 W



Corrosion
Proof

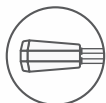

Shock-proof
Model



3-pin
Cord



ISI Approved
3-core Supply
Cord

- Heavy-duty copper tube filled with magnesium oxide for durability
- ISI approved 3-core supply cord with moulded 3-pin plug

2 YEARS REPLACEMENT
WARRANTY



PREPARE
DELICACIES
WITH EASE



MIXER
GRINDER





**Powerful
900 W**

GALAXY | Mixer Grinder



3-speed
Control



30 Minutes
Rating



Food Grade
Transparent
& SS Jars



Rated Power
900 W



Shock-proof
ABS Body



Auto
Shut-off



Skid
Resistant



Powerful
100% Copper
Motor



Stainless Steel
Multi-purpose
Blades



ISI
Approved

- 3-speed control with pulser incher
 - 30 minutes rating (3 minutes ON & 2 minutes OFF)
 - Auto shut-off with overload protector
 - High-grade stainless steel multi-purpose blades
 - Genuine food grade & shock-proof ABS body
 - Transparent polycarbonate blending jars & stainless steel jars* with dome and cap
 - Skid resistant vacuum legs
 - Speed 19000 RPM
 - **5 years warranty on the motor & 2 years warranty on the product
- *Liquidising Jar – 1500 ml, Dry Grinding Jar – 1000 ml, Chutney Jar – 400 ml

5 YEARS
WARRANTY**

Powerful
750 W



MARVEL | Mixer Grinder



3-speed
Control



30 Minutes
Rating



Food Grade
SS Jars



Rated Power
750 W



Shock-proof
ABS Body



Auto
Shut-off



Skid
Resistant



Powerful
100% Copper
Motor



Stainless Steel
Multi-purpose
Blades



ISI
Approved

- 3-speed control with incher
 - 30 minutes rating (3 minutes ON & 2 minutes OFF)
 - Auto shut-off with overload protector
 - Food grade & shock-proof ABS body
 - Stainless steel jars* and PC dome with buckle clips for secured locks & handsfree operation
 - **5 years warranty on the motor & 2 years warranty on the product
- *Liquidising Jar – 1500 ml, Dry Grinding Jar – 1000 ml, Chutney Jar – 400 ml

5 YEARS**
WARRANTY





**Powerful
750 W**

MIXO 750 | Mixer Grinder



3-speed
Control



30 Minutes
Rating



Food Grade
SS Jars



Rated Power
750 W



Shock-proof
ABS Body



Auto
Shut-off



Skid
Resistant



Powerful
100% Copper
Motor



Stainless Steel
Multi-purpose
Blades



ISI
Approved

- 3-speed control with incher
 - 30 minutes rating (3 minutes ON & 2 minutes OFF)
 - Auto shut-off with overload protector
 - Food grade & shock-proof ABS body
 - Stainless steel jars* with transparent PC dome (secure lock for liquid jar)
 - **5 years warranty on the motor & 2 years warranty on the product
- *Liquidising Jar (secure lock) – 1500 ml, Dry Grinding Jar – 1000 ml, Chutney Jar – 400 ml

5 YEARS
WARRANTY**



MIXO 500 | Mixer Grinder



3-speed
Control



30 Minutes
Rating



Food Grade
SS Jars



Shock-proof
ABS Body



Auto
Shut-off



Skid
Resistant



Powerful
100% Copper
Motor



Stainless Steel
Multi-purpose
Blades



ISI
Approved

- 3-speed control with incher
 - Rated power 500 W
 - 30 minutes rating (3 minutes ON & 2 minutes OFF)
 - Auto shut-off with overload protector
 - Food grade & shock-proof ABS body
 - Stainless steel jars* with lid
 - **5 years warranty on the motor & 2 years warranty on the product
- *Liquidising Jar – 1250 ml, Dry Grinding Jar – 800 ml, Chutney Jar – 400 ml



5 YEARS**
WARRANTY



ULTRA MIX | Mixer Grinder



3-speed
Control



30 Minutes
Rating



Food Grade
SS Jars



Advance
Air Ventilation
System



Shock-proof
ABS Body



Auto
Shut-off



Skid
Resistant



Powerful
100% Copper
Motor



Stainless Steel
Multi-purpose
Blades



ISI
Approved

- 3-speed control with incher
- Rated power 500 W
- 30 minutes rating (3 minutes ON & 2 minutes OFF)
- Auto shut-off with overload protector
- Food grade & shock-proof ABS body
- Stainless steel jars*
- **5 years warranty on the motor & 2 years warranty on the product

*Liquidising Jar – 1250 ml, Dry Grinding Jar – 800 ml, Chutney Jar – 400 ml

5 YEARS**
WARRANTY



MONARCH 500 | Mixer Grinder



3-speed
Control



30 Minutes
Rating



Food Grade
SS Jars



Shock-proof
ABS Body



High-speed
Universal
Motor



Auto
Shut-off



Skid
Resistant



ISI
Approved



- 3-speed control with incher
 - Rated power 500 W
 - 30 minutes rating (3 minutes ON & 2 minutes OFF)
 - Auto shut-off with overload protector
 - Food grade (SS304) stainless steel jars* with lid
 - Anti-skid vacuum feet
- *Liquidising Jar – 1250 ml, Dry Grinding Jar – 800 ml, Chutney Jar – 400 ml

3 YEARS
WARRANTY



SPYDER 500 | Mixer Grinder



3-speed
Control



30 Minutes
Rating



Food Grade
SS Jars



Shock-proof
ABS Body



Auto
Shut-off



Skid
Resistant



Powerful
Universal
Motor



Stainless Steel
Multi-purpose
Blades



ISI
Approved

- 3-speed control with incher
- Rated power 500 W
- 30 minutes rating (3 minutes ON & 2 minutes OFF)
- Auto shut-off with overload protector
- Food grade & shock-proof ABS body
- Stainless steel jars* with lid

*Liquidising Jar – 1250 ml, Dry Grinding Jar – 800 ml, Chutney Jar – 400 ml

2 YEARS
WARRANTY



WINMIX | Mixer Grinder



3-speed
Control



30 Minutes
Rating



Food Grade
SS Jars



Auto
Shut-off



Anti-skid
Vacuum
Feet



High-speed
Universal
Motor



Stainless Steel
Multi-purpose
Blades



ISI
Approved

- 3-speed control with incher
- 19000 RPM & 500 W high-speed universal motor
- 30 minutes rating (3 minutes ON & 2 minutes OFF)
- Auto shut-off with overload protector
- Food grade stainless steel jars* with lid
- **5 years warranty on the motor & 2 years warranty on the product

*Liquidising Jar – 1200 ml, Dry Grinding Jar – 750 ml, Chutney Jar – 350 ml

5 YEARS**
WARRANTY



JUICER MIXER
GRINDER



GALAXY | Juicer Mixer Grinder



30 Minutes
Rating



Shock-proof
ABS Body



Auto
Shut-off



Powerful
Motor



Anti-skid
Vacuum
Feet



Stainless
Steel Blades
(SS304)



ISI
Approved



- 3-speed control with incher
- 30 minutes rating (3 minutes ON & 2 minutes OFF)
- Auto shut-off with overload protector
- Food grade & shock-proof ABS body
- Transparent liquidising jar (1.5 L)
- Stainless steel grinding jar (0.8 L)
- Rated power 500 W

2 YEARS
WARRANTY

SATISFY YOUR
CRAVINGS WITH
A QUICK BREW



ELECTRIC
KETTLE



GALAXY 1.5 SS | Electric Kettle



Neon ON
Indicator

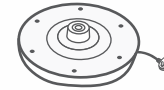

Cord Storage
Facility



360° Cordless
Operation



Pull
Open Lid



Auto Shut-off
Function



Stainless
Steel Body



Capacity
1.5 L

- Stylish design
- Rated power 1500 W
- Corrosion proof stainless steel body

1 YEAR
WARRANTY

GALAXY 1.8 SS | Electric Kettle



Neon ON
Indicator

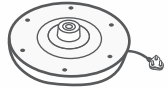

Cord Storage
Facility



360° Cordless
Operation



Pull
Open Lid



Auto Shut-off
Function



Stainless
Steel Body



Capacity
1.8 L

- Stylish design
- Rated power 1500 W
- Corrosion proof stainless steel body



1 YEAR
WARRANTY

UPGRADE YOUR
CULINARY SKILLS
IN STYLE



INDUCTION
COOKER



CM 11 | Induction Cooker



LED Digital
Display



Overheat
Protection



Push Button
Control



Child Safety
Lock



Auto Safety
Shut-off



Multiple
Heat Settings



Rated Power
1600 W



ISI
Approved

- Automatic voltage regulator
- Quick heating
- 7 preset menu



1 YEAR
WARRANTY

CM 12 | Induction Cooker



Digital Timer Control



Overheat Protection



Touch Button Control



Fully Polished Glass Top



Auto Safety Shut-off



Multiple Heat Settings



Rated Power 2000 W



ISI Approved

- Automatic voltage regulator
- Quick heating
- 8 preset menu



1 YEAR WARRANTY

ELECTRIC
IRON

LOOK GOOD
EFFORTLESSLY



1000H1 | Electric Dry Iron



Heavyweight
(1.5 Kg)

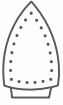

Non-stick
PTFE Coated
Soleplate



Multiple
Temperature
Settings



360°
Swivel Cord



Thermostat
with Safety
Fuse



Rated Power
1000 W



ISI
Approved

- Bimetallic thermostat for automatic temperature control
- Cool touch handle with comfortable grip
- Super clean surface finish with pleasant aesthetics
- Ideal for heavy-duty pressing
- Multiple temperature settings for different fabrics

2 YEARS REPLACEMENT
WARRANTY





1000P6 | Electric Dry Iron



Ultra
Lightweight



Non-stick
PTFE Coated
Soleplate



Multiple
Temperature
Settings



360°
Swivel Cord



Thermostat
with Safety
Fuse



Rated Power
1000 W



ISI
Approved

- Ergonomic design with bi-colour combo
- Instant heating & powerful performance
- Bimetallic thermostat for automatic temperature control
- Reliable snap-action thermostat
- Multiple temperature settings for different fabrics
- Ultra lightweight cool touch body

2 YEARS REPLACEMENT
WARRANTY



1000P7 | Electric Dry Iron



Ultra
Lightweight



Non-stick
PTFE Coated
Soleplate



Multiple
Temperature
Settings



360°
Swivel Cord



Thermostat
with Safety
Fuse



Rated Power
1000 W



ISI
Approved

- Ergonomic design with bi-colour combo
- Instant heating & powerful performance
- Bimetallic thermostat for automatic temperature control
- Reliable snap-action thermostat
- Multiple temperature settings for different fabrics
- Ultra lightweight cool touch body

2 YEARS REPLACEMENT
WARRANTY



1000M7 | Electric Dry Iron



Heavy-duty
Lightweight



Non-stick
PTFE Coated
Soleplate



Multiple
Temperature
Settings



360°
Swivel Cord



Thermostat
with Safety
Fuse



Rated Power
1000 W



ISI
Approved

- Heavy-duty lightweight metal body
- Bimetallic thermostat for automatic temperature control
- Cool touch handle with comfortable grip
- Super clean surface finish with pleasant aesthetics & tangle-free cord
- Multiple temperature settings for different fabrics

2 YEARS REPLACEMENT
WARRANTY

750M2 | Electric Dry Iron



Heavy-duty
Lightweight



Non-stick
PTFE Coated
Soleplate



Multiple
Temperature
Settings



360°
Swivel Cord



Thermostat
with Safety
Fuse



Rated Power
750 W



ISI
Approved

- Heavy-duty lightweight metal body
- Bimetallic thermostat for automatic temperature control
- Cool touch handle with comfortable grip
- Super clean surface finish with pleasant aesthetics & tangle-free cord
- Multiple temperature settings for different fabrics

2 YEARS REPLACEMENT
WARRANTY

SANDWICH
MAKER

PUT TOGETHER
A MOUTH-
WATERING
SNACK
INSTANTLY



GALAXY | Sandwich Maker



Non-stick
Heating Plate



Deeper
Pockets



Overheat
Protection



Broad
Hand Lock



Dual LED
Indicators



Rated Power
750 W



ISI
Approved

- Non-stick heating plate for oil free toasting
- Powerful performance & faster heating with 750 W rated power
- Deeper pockets for extra filling in every sandwich
- Heat-resistant bakelite body for cool touch operation
- Overheat protection with thermal fuse
- Broad hand lock for easy & comfortable locking
- Dual LED indicators for easy & convenient usage

1 YEAR
WARRANTY



ROOM
HEATER

A PLEASANT
ATMOSPHERE IN
EVERY CORNER



COMFORT

Halogen Heater



3 Halogen
Heating
Elements



Rust-free
Stainless Steel
Reflector



3 Heat
Settings



Safety
Mesh Grille

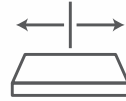

Wider Base
for Better
Stability



Wider Angle
Oscillation



Long-lasting
Uniform
Heating



Heat-resistant
Plastic Body



Safety
Tip-over
Switch



ISI
Approved

- Very elegant look with a wide base
- Cool touch body
- 3 heat settings – 400/800/1200 W
- Rated power – 400/800/1200 W

1 YEAR
WARRANTY



LAVA | Quartz Heater



Quartz Tube
Heating
Element



Rust-free
Stainless Steel
Reflector



Safety
Mesh Grille



Dual
Heating Power
Settings



Long-lasting
Uniform
Heating



Heat-resistant
Plastic Body



Safety
Tip-over
Switch



Rated Power
400/800 W



ISI
Approved

- Highly efficient quartz tube heating element
- Slim & sleek design
- Dual heating power settings – 400 W & 800 W

1 YEAR
WARRANTY



HOTWAVE | Quartz Heater



Quartz Tube
Heating
Element



Rust-free
Stainless Steel
Reflector



Safety
Mesh Grille



Cool
Touch Body



Dual Heating
Power Settings



Heat-resistant
Plastic Body



Easy to
Carry



Safety
Tip-over
Switch



Rated Power
400/800 W



ISI
Approved

- Highly efficient quartz tube heating element
- Slim & sleek design
- Dual heating power settings – 400 W & 800 W



1 YEAR
WARRANTY



LAVA+ | Quartz Heater



Quartz Tube
Heating
Element



Rust-free
Stainless Steel
Reflector



Safety
Mesh Grille



Cool
Touch Body



Dual Heating
Power Settings



Long-lasting
Uniform
Heating



Heat-resistant
Plastic Body



Safety
Tip-over
Switch



Rated Power
400/800 W



ISI
Approved

- Highly efficient quartz tube heating element
- Slim & sleek design
- Dual heating power settings – 400 W & 800 W



1 YEAR
WARRANTY



VISTRON | Heat Convector



Dual Heating
Positions



Twin Turbo
Fans



Safety
Thermal Cut-out



Cool Touch
Handle for Easy
Movement



Temperature
Control



Adjustable
Height



Rated Power
1000/2000 W



ISI
Approved

- Modern & sleek design
- Dual heating positions for better heating – low (1000 W) & high (2000 W)
- Sturdy body
- Night lamp indicator
- Twin turbo fans for uniform heating

1 YEAR
WARRANTY



LAVA | Fan Heater



Two Heat
Positions



Safety
Thermal Cut-out



Cool
Airflow



Heat-resistant
Plastic Body



Rated Power
1000/2000 W



ISI
Approved

- Two heat positions for better heating
- Cool airflow for summer use
- Pilot light
- Portable design
- Childproof grille
- Heat-resistant & shock-proof plastic body

1 YEAR
WARRANTY



GLEAM | Ceramic Heater



Anti-corrosion
Powder Coated
Body



Nickel Chrome
Plated Mesh
Guard



Rust-free
Stainless Steel
Reflector



Quick & Efficient
Heating



Rated Power
1000 W



ISI
Approved



- Compact & stylish design
- Energy-efficient

2 YEARS
WARRANTY

PLUG IN YOUR
ELECTRONICS WITHOUT
MOVING AN INCH

EXTENSION REEL &
SURGE PROTECTOR





EXTENSION REEL

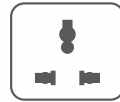

Universal Connector Port



Master Switch with LED Indicator



360° Smooth Rotation



Rated Power 1500 VA



4 Metres Long High-quality Cable

- 4 metres long high-quality cable for extended reach





SURGE PROTECTOR

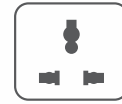

Universal
Connector Port



Single Power
Switch



LED
Indicator



Rated Power
1500 VA



High-quality
Cable



Heat-resistant
Body



Voltage
Fluctuation
Protector

- Manages load up to 1.5 kW
- Cord length variants – 1.5, 2 & 2.5 metres

INSTALLATION DIAGRAM

WATER HEATER

Aquahot

*Mounting Dimension's Tolerance is $\pm 1\%$

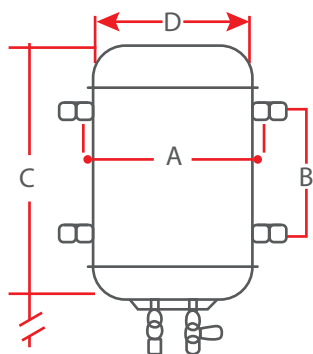

Vertical Mounting

Mounting Dimensions

Model	Capacity	Mounting	Mounting dimensions in mm			
			A	B	C	D
Aquahot	6 L	Vertical	195	130	325	255
	10 L	Vertical	195	175	375	255
	15 L	Vertical	215	215	405	305
	25 L	Vertical	215	220	450	355
	35 L	Vertical	285	260	500	380
	50 L	Vertical	290	385	620	420

Gush & Marbella

*Mounting Dimension's Tolerance is $\pm 1\%$

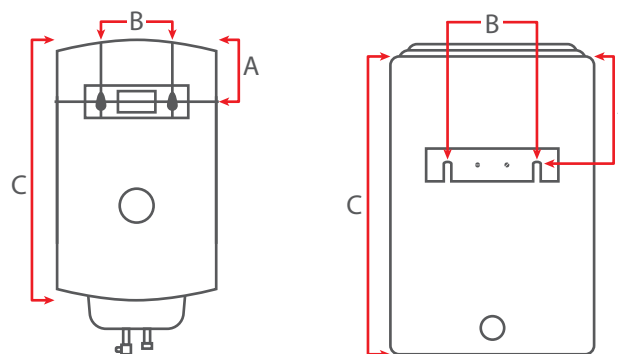

Gush

Marbella

Mounting Dimensions

Model	Capacity	Mounting	Mounting dimensions in mm		
			A	B	C
Gush	6 L	Vertical	75	175	324
	10 L	Vertical	80	175	333
	15 L	Vertical	156	175	433
	25 L	Vertical	122	175	496
Marbella	10 L	Vertical	165	175	480
	15 L	Vertical	190	175	495
	25 L	Vertical	185	175	535

INSTALLATION DIAGRAM

WATER HEATER

Lava

*Mounting Dimension's Tolerance is $\pm 1\%$

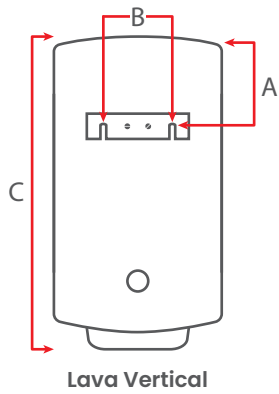

Mounting Dimensions

Model	Capacity	Mounting	Mounting dimensions in mm		
			A	B	C
Lava	10 L	Vertical	80	175	333
	15 L	Vertical	156	175	433
	25 L	Vertical	122	175	496

Lava+

*Mounting Dimension's Tolerance is $\pm 1\%$

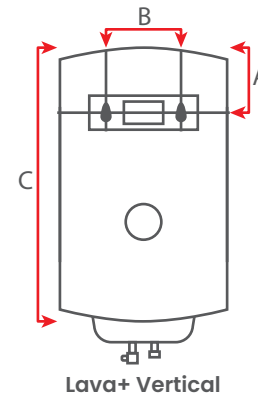

Mounting Dimensions

Model	Capacity	Mounting	Mounting dimensions in mm		
			A	B	C
Lava+	10 L	Vertical	80	175	333
	15 L	Vertical	156	175	433
	25 L	Vertical	122	175	496

INSTALLATION DIAGRAM

WATER HEATER

Legacy+

*Mounting Dimension's Tolerance is $\pm 1\%$

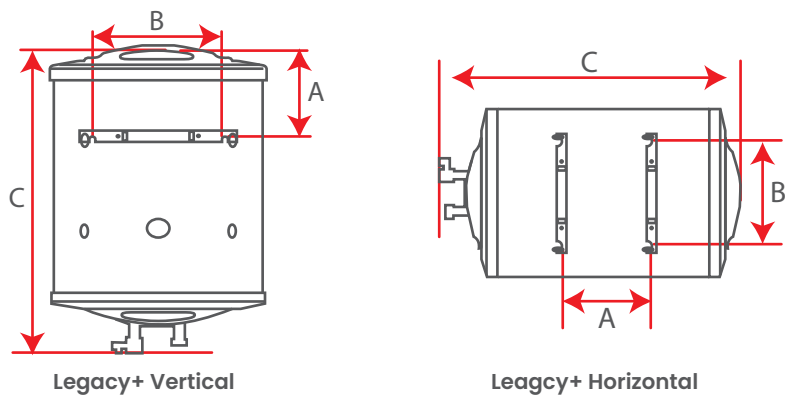

Mounting Dimensions

Model	Capacity	Mounting	Mounting dimensions in mm		
			A	B	C
Legacy+	6 L	Vertical	150	222	415
	10 L	Vertical	150	222	475
	15 L	Vertical	190	222	550
	25 L	Vertical	220	222	600
	15 L	Horizontal	240	180	320
	25 L	Horizontal	240	215	370

Freshet

*Mounting Dimension's Tolerance is $\pm 1\%$

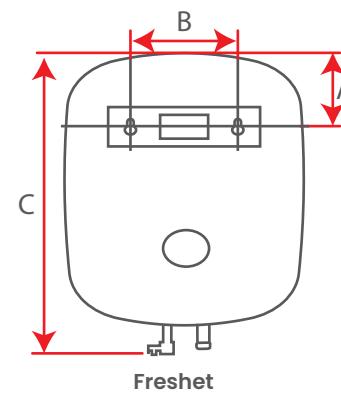

Mounting Dimensions

Model	Capacity	Mounting	Mounting dimensions in mm		
			A	B	C
Freshet	6 L	Vertical	150	175	355
	10 L	Vertical	200	180	500
	15 L	Vertical	185	180	510
	25 L	Vertical	185	180	580

BRANCHES

SOUTH

Chennai +91 89398 96009, bmmms@polarelectric.in | Madurai +91 72990 33418, bmmdad@polarelectric.in
Kochi +91 62922 59196, bmcoc@polarelectric.in | Bengaluru +91 91471 05489, bmbng@polarelectric.in
Vijayawada +91 76050 83472, bmvij@polarelectric.in | Hyderabad 90739 55030, bmhyd@polarelectric.in

EAST

Kolkata +91 62922 59198, bmkol@polarelectric.in | Bhubaneswar +91 90739 54614, bmbbs@polarelectric.in
Guwahati +91 90739 54651, bmguw@polarelectric.in | Patna +91 62923 11682, bmptn@polarelectric.in
Ranchi +91 62923 05911, bmran@polarelectric.in

NORTH

Delhi +91 90739 54778, bmdei@polarelectric.in | Chandigarh (0172) 507 7258/90739 54765, bmchd@polarelectric.in
Jaipur (0141) 403 6715/90510 56567, bmjpr@polarelectric.in | Kanpur +91 90739 54616, bmknj@polarelectric.in
Ghaziabad +91 62923 17385, bmgbz@polarelectric.in | Dehradun +91 62922 65331, bmddn@polarelectric.in
Varanasi +91 62922 97887, bmvns@polarelectric.in

WEST & CENTRAL

Mumbai (02522) 661 973/90739 55042, bmmum@polarelectric.in | Ahmedabad +91 76040 35557, bmahm@polarelectric.in
Indore +91 91471 32821, bmind@polarelectric.in | Raipur +91 90739 54648, bmpr@polarelectric.in

VISHVA ELECTROTECH LTD.

CIN: U31501WB2009PLC132426 (Licensed user of POLAR Trade Mark)

Regd. Off.: Unit No. 8B & 8C, 8th Floor, 23 Circus Avenue, Kolkata 700 017, West Bengal, India



Makes life easy

☎ (033) 6629 1829

✉ customercare@polarelectric.in | info@polarelectric.in

🌐 www.polarelectric.in

📘 www.facebook.com/PolarIndia



Customer Care
033 6100 6100

We at Polar, have a policy of continuous improvements. Hence, product specifications and aesthetics may change without prior notice.